

Topology Control in Wireless Sensor Networks

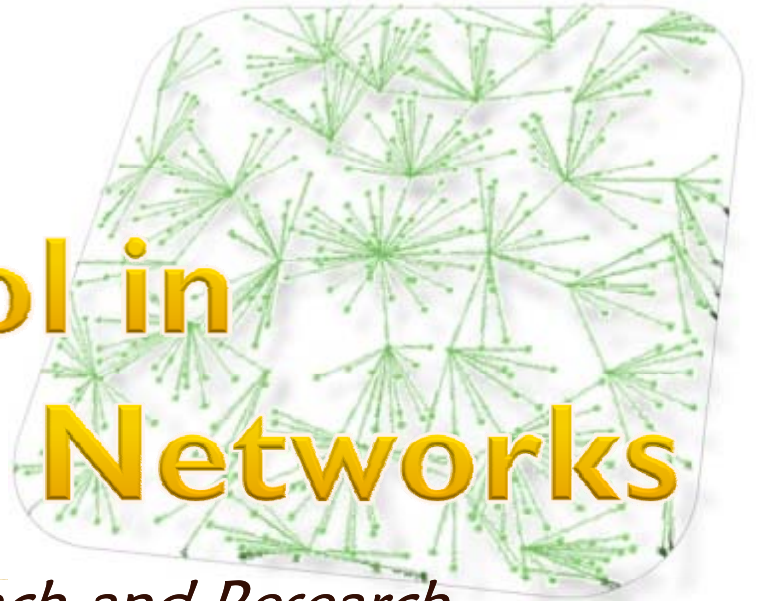

*and Atarraya, a Simulation Tool to Teach and Research
Topology Control Algorithms for Wireless Sensor Networks*

Pedro M. Wightman

*Universidad del Norte
Departamento de Ingeniería de Sistemas
Barranquilla, Atlántico, Colombia
pwightman@uninorte.edu.co*



Miguel A. Labrador

*University of South Florida
Dept. of Computer Science and Engineering
Tampa, Florida, USA
labrador@cse.usf.edu*





Outline

- Wireless sensor networks and topology control
- What is Atarraya?

- Things to know before using Atarraya
- Connectivity-oriented Topology Construction
- Coverage-oriented Topology Construction
- Topology Maintenance
- Conclusions

Wireless Sensor Networks - WSNs

- An autonomous system of nodes connected by wireless links forming an arbitrary topology without necessarily using a pre-existing and fixed infrastructure
- Network may or may not be connected to a fixed infrastructure
- Formed by wireless devices which may be mobile
 - Routes may break
- Routes between nodes may potentially contain multiple hops
 - Nodes are end systems and routers
- **Nodes are battery-powered**

Wireless Sensor Devices and Networks

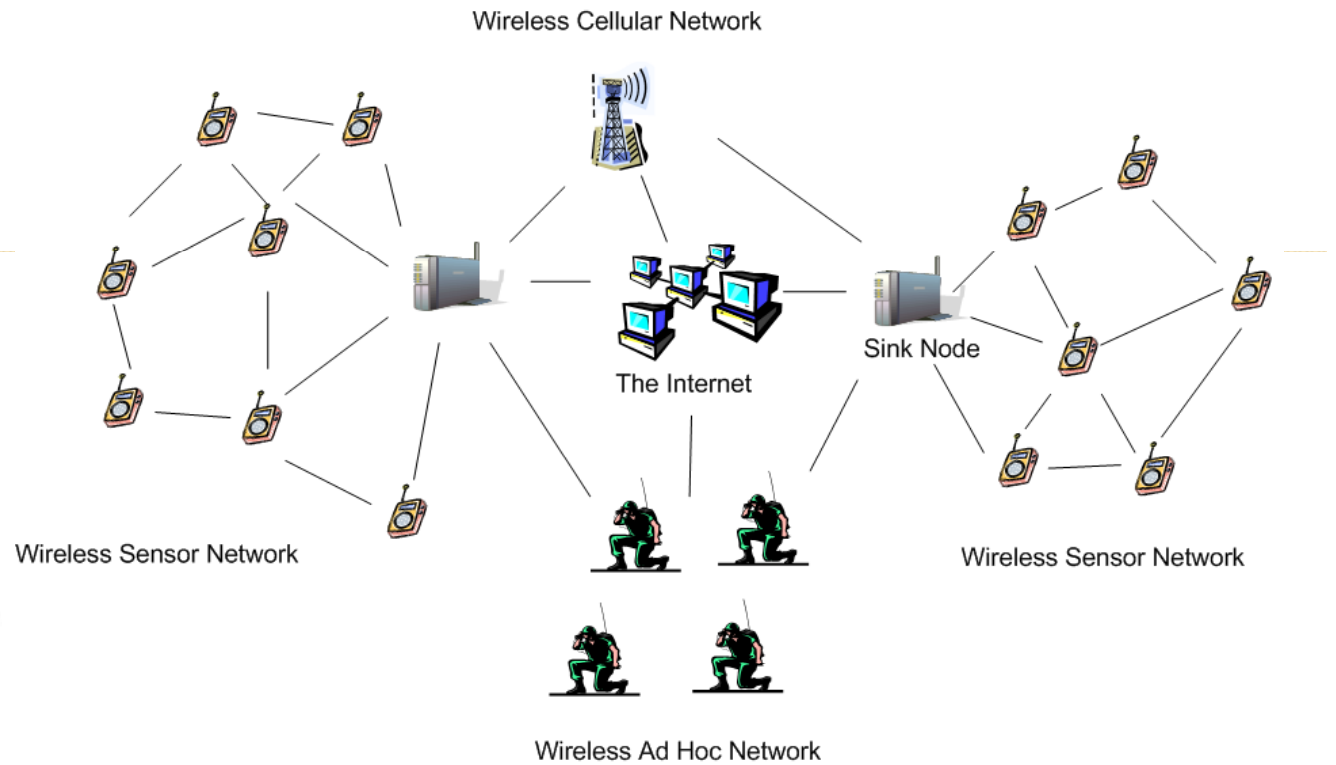
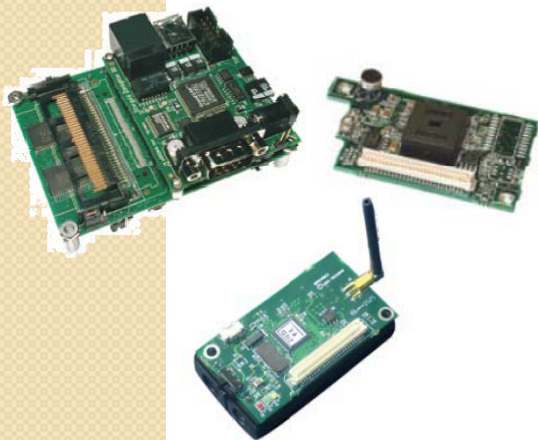
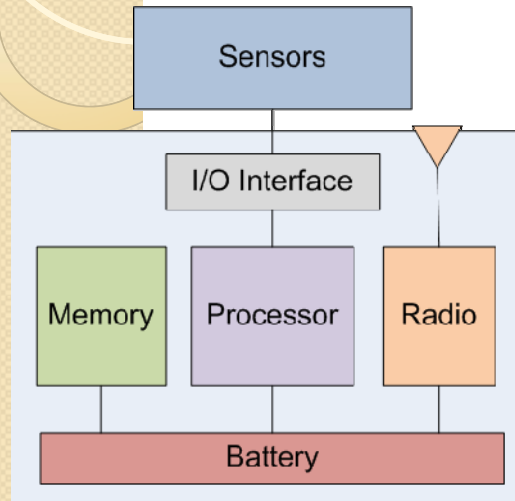

Network Topology

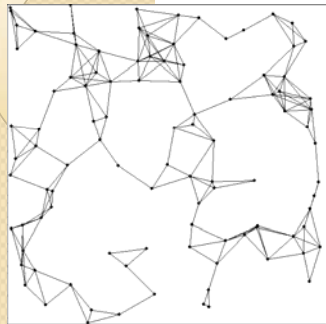

100 Nodes
80m Tx Range

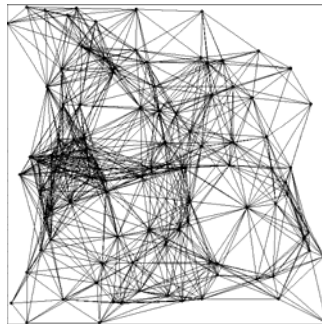

100 Nodes
160m Tx Range

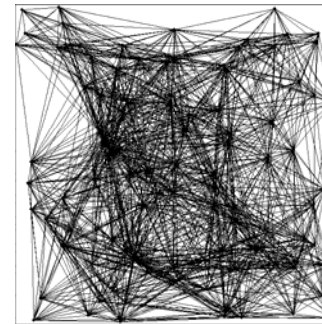

100 Nodes
240m Tx Range

- The MaxPowerGraph is not a good graph for communication
 - Excess of interference and collision
 - Reduced capacity
 - Redundant information
 - Nodes that are practically in the same location are sensing the same events, and thus, sending the same information

**These problems are a major source of energy consumption!
The topology of the network must be changed!**

Reducing the Network Topology

- There are two main ways to reduce the topology of a network, and therefore save energy and increase the network lifetime

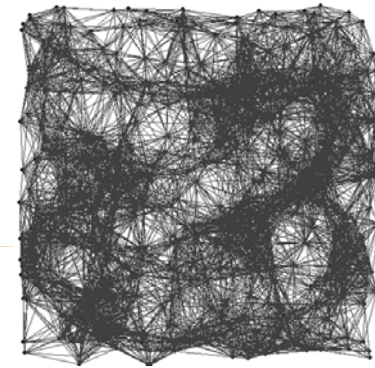

- *Changing TX range*
 - Critical Transmission Range
 - Range Assignment
 - Minimal Spanning Tree
 - ...
- *Creating a hierarchy*
 - Minimal Connected Dominating Set
 - Clustering
 - ...

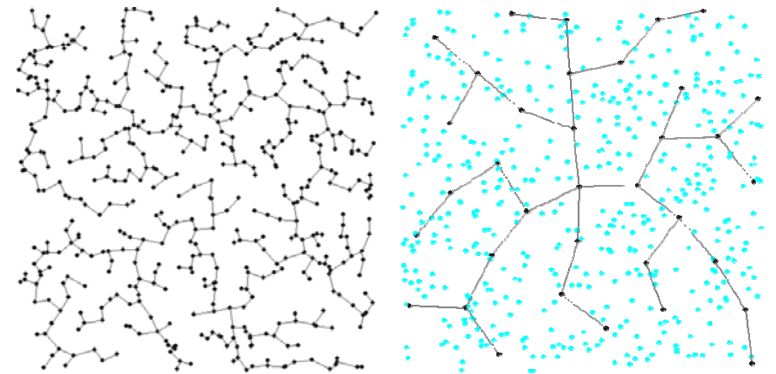

Update the Reduced Network Topology

- Once a reduced topology is selected, and starts working, it starts consuming its energy until the point it stops being optimal
 - At this point it needs to be changed
- There are several ways to change the reduced topology:
 - Recreation
 - Create a new one “on the fly” (Dynamic)
 - Global or local
 - Rotation
 - Rotate among several pre-calculated reduced topologies (Static)
 - Rotate until it is possible, then restore (Hybrid)

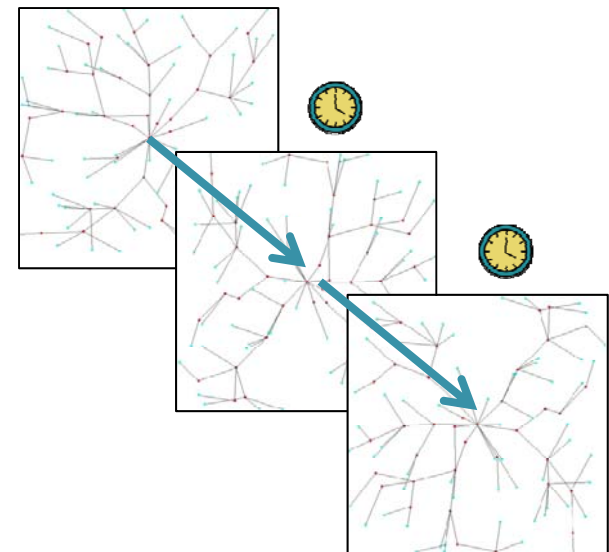
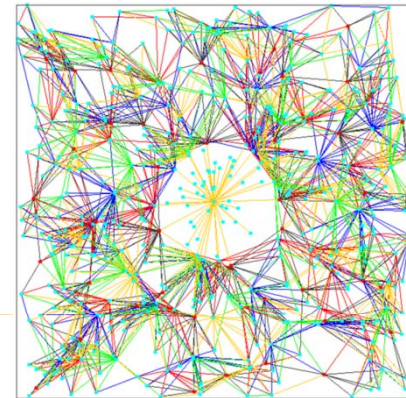

Topology Control - TC

Topology Control is the reorganization and management of certain **node parameters** and **modes of operation** from **time to time** to **modify the topology** of the network with the goal of extending its lifetime while preserving important characteristics, such as network **connectivity** and sensing **coverage**.

Topology Control - TC

Topology Control is an iterative process.

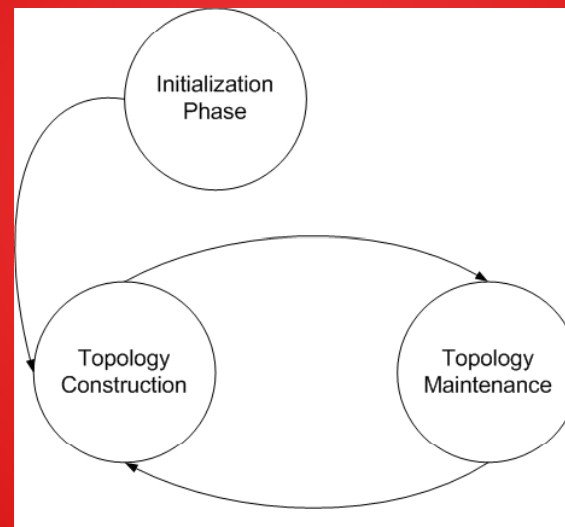

Taxonomy for Topology Control

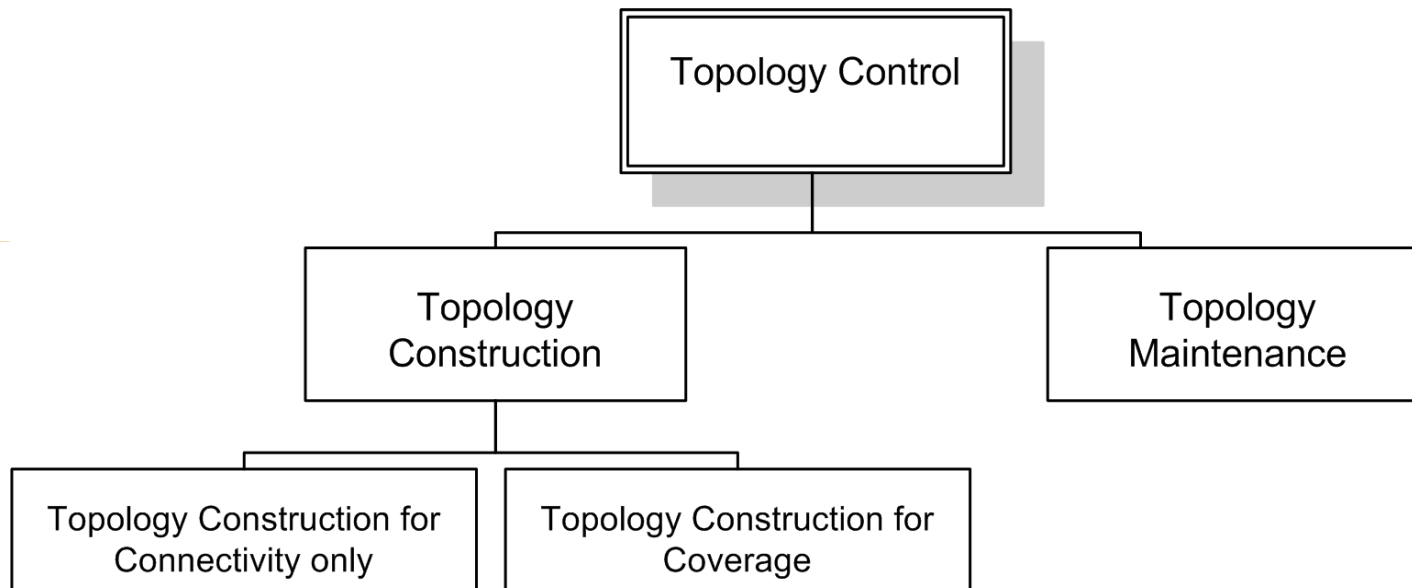

- Atarraya offers protocols in all this categories, and allows combination of topology construction and topology maintenance protocols to evaluate joint behavior

What is Atarraya?

- Atarraya is an event-driven simulator to design, evaluate, and teach topology control algorithms
- Atarraya support 4 types of algorithms:
 - **Topology Construction:** Topology reduction
 - **Topology Maintenance:** Maintenance policy
 - **Sensor Protocols:** Sensor manager, data aggregation
 - **Routing Protocols:** Forwarding, routing tables
 - **Mobility Protocols:** Random walks
- Developed in Java, which makes Atarraya portable to any platform
- Free software, under GNU V. 3 license

What is Atarraya?

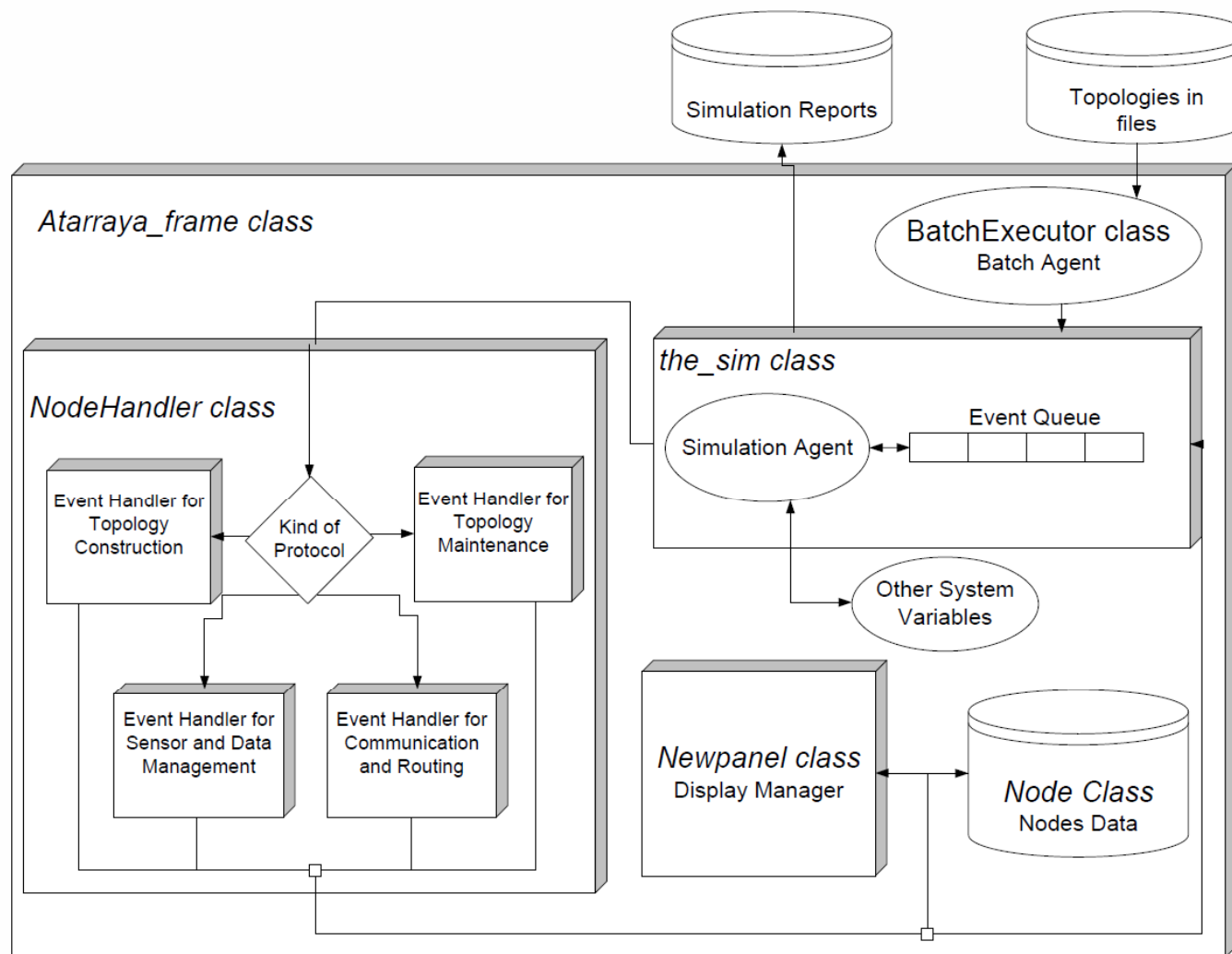



Things to Know Before Using Atarraya

- No MAC layer is implemented
 - If a packet is lost, there will be no retransmission

- Atarraya supports Multiple *Virtual Network Infrastructures - VNI*
 - There may be more than one sink in the network
 - The network can define several logical trees
 - This feature is not included in most network simulators

Things to Know Before Using Atarraya

- Energy model - Simple

- The energy model included in Atarraya is based on the following formulas, taken from (Heinzelman et al., 2002):

$$E_{Txbit} = E_{elect} + E_{amp} \cdot (\pi \cdot r^2)$$

$$E_{Rxbit} = E_{elect}$$

- Energy consumed during idle state is negligible
 - To be corrected in next versions of Atarraya
- Sink node has an infinite source of energy
- Nodes are assumed to have a low-energy consumption mechanism to be awakened by other nodes when the main radio is turned off

Things to Know Before Using Atarraya

- Energy model - Mote
 - This energy model is based on the following specifications of energy consumption from X-Bow Motes (in mA-h):
 - PROCESSOR
 - ACTIVE_CONSUMPTION= 8
 - IDLE_CONSUMPTION= 3.2
 - SLEEP_CONSUMPTION= 0.103;
 - SENSOR
 - ACTIVE_CONSUMPTION= 5;
 - IDLE_CONSUMPTION= 0.7;
 - SLEEP_CONSUMPTION= 0.005;
 - RADIO
 - TX_CONSUMPTION= 12;
 - RX_CONSUMPTION= 7;
 - SLEEP_CONSUMPTION= 0.001;
 - TX_RX_TIME_BYTE= 416e-6;
 - Sink node has an infinite source of energy
 - Nodes are assumed to have a low-energy consumption mechanism to be awoken by other nodes when the main radio is turned off



Things to Know Before Using Atarraya

- Communication model
 - Classic unit disk transmission range
 - Constant bit error rate on all transmissions
 - Atarraya assumes that a data link layer exists, but does not model it. It tries to represent the effect of its actions (contention, retransmission, etc.) by adding a uniformly distributed random delay time to every packet transmission
- Both communication and energy models can be adapted to the needs of the experiments

Things to Know Before Using Atarraya

General scheme of the main window

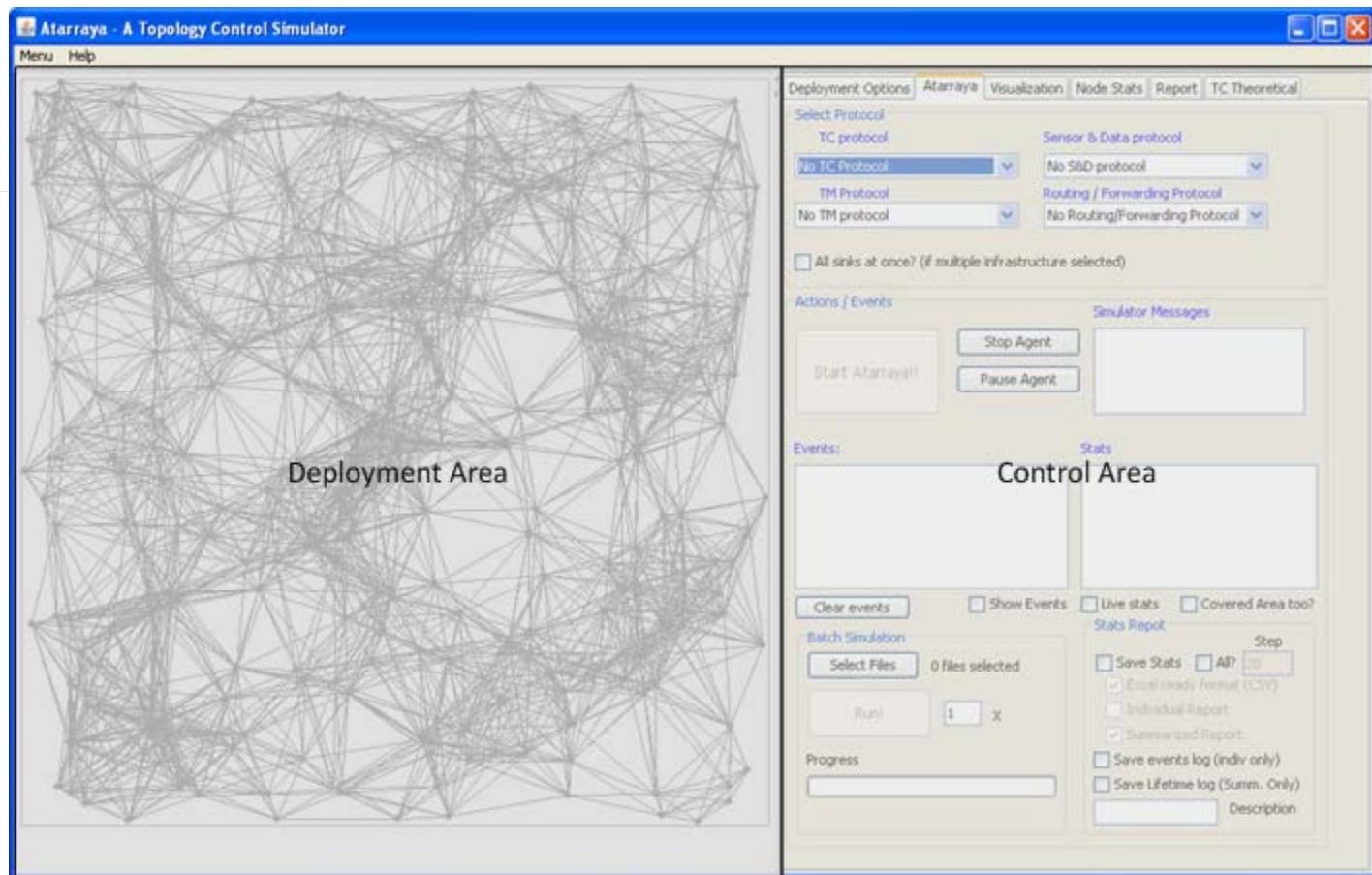

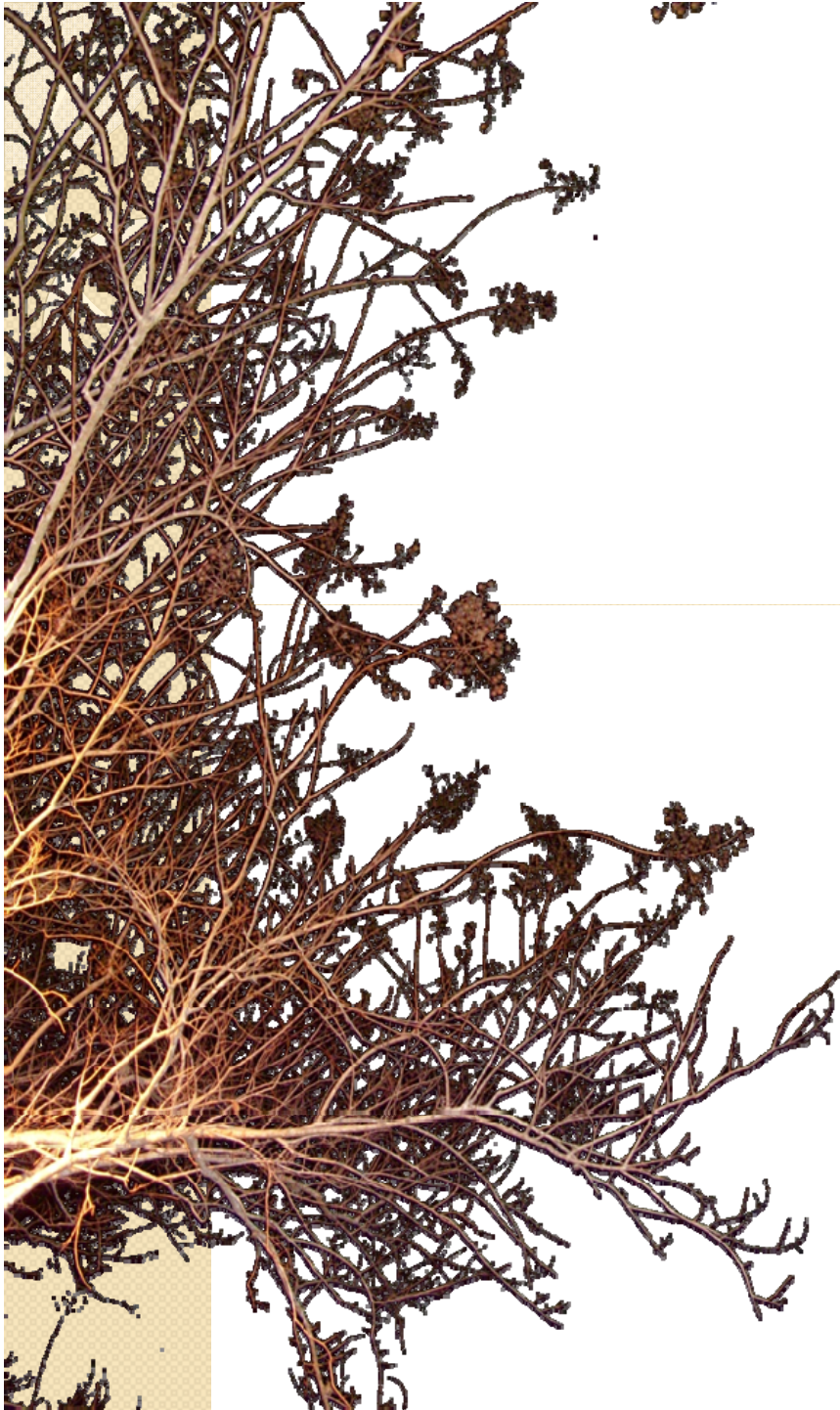

Connectivity-Oriented Topology Construction



Connectivity-Oriented Topology Construction

- One of the main concerns when any topology control mechanism is applied is to keep the network connected
 - Saving energy can be sacrificed if connectivity is to be guaranteed
- Several ways have been proposed to determine if a network is connected, for example:
 - Minimum Node Degree
 - Critical Transmission Range (CTR)
 - Range assignment problem (RA)
 - Connected Dominating Sets
- Of course, these techniques are probabilistic and work based on average behavior



Connectivity-Oriented Topology Construction

- There are many ways to reduce a topology:
 - Control the transmission range to decrease the amount of energy used in communication
 - Create a hierarchy that will:
 - Limit broadcast domain by defining clusters or communication backbones
 - Control the number of active nodes in order to have nodes in reserve to replace the dead ones
 - Change the topology according to the present needs of the network
 - Hybrid approaches that combine two or more methods

Critical Transmission Range

- This technique determines the longest edge of the minimal spanning tree
 - If the radius of every node in the topology is changed to this value, connectivity will be guaranteed
- There are two well known formulas:
 - Penrose
 - This formula applies for dense networks
 - Santi-Blough
 - This formula applies to sparse networks

Critical Transmission Range

- Penrose's formula is defined as follows:

$$CTR_{dense} = \sqrt{\frac{\ln n + f(n)}{n\pi}},$$

$$\lim_{n \rightarrow \infty} f(n) = \infty$$

- The accuracy of this and similar formulas can be assessed using the Giant Component test



Giant Component

- The Giant Component is a very well known effect of the communication radius on the connectivity of a random graph
 - This experiment shows how the size of the greatest connected component (or subgraph) changes based on the communication radius
 - Another important metric is the ratio of connected topologies, which describes the probability of having a connected topology with a given radius
- Atarraya can perform the test for regular random topologies (the classic test) or for sparse topologies, which will be defined later



Classic GC Test

- The way to perform this test in Atarraya is as follows:
 - Start with a given radius, expressed as a percentage of the area side; for example, 1% of the area side
 - Test connectivity and the size of the greatest component for a given set of random topologies
 - Increase the radius by a certain ratio, for example, 2% of the area side, and test again
 - The test will run until all tested topologies are connected

Classic GC test

- One thing to look for on the results is that the curve shows how, in order to reach 90% - 100% connectivity, the radius has to be increased greatly compared to a fast grow seen in smaller degrees of connectivity
- This experiment is very useful to determine appropriate transmission ranges for networks with certain characteristics
 - It can be used also to verify the Critical Transmission Range (CTR) from the theoretical formulas



**EXPERIMENTS
PART I –
GIANT COMPONENT**

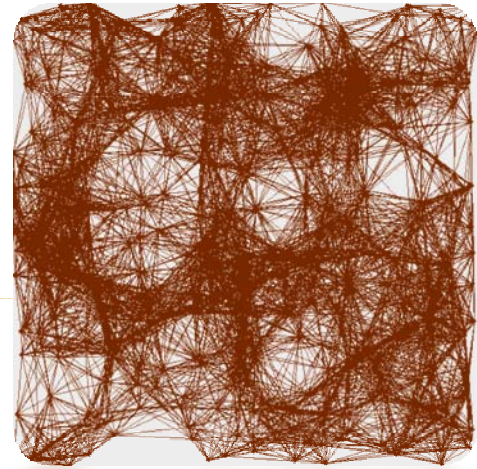

Experiment I-a

- Area: 500 x 500mts
- Evaluation on 100 random topologies
- Nodes
 - 200 nodes, uniformly distributed in the area
- Communication radius
 - Initial radius: 1% of the area side (5mts)
 - Radius Increment ratio: 2% of the area side on each step (10mts)
- Results
 - Average size of the greatest component
 - Percentage of connected topologies
 - Average node degree

Definition of Parameters

- From the initial window in Atarraya, go to the ***TC Theoretical*** tab

The screenshot shows the 'TC Theoretical' tab in the Atarraya software. The interface is divided into several sections:

- CTR Dense Topologies:** Contains a 'Dense' radio button (circled), 'Num Nodes' (100), 'Initial CTR' (0.01), 'CTR Step' (0.01), and CTR values for 'Penrose-Santi', 'Santi and Blough', and 'Current' (all 0).
- CTR Sparse Topologies - Experiment 3 For 2 dimensions:** Contains a 'Sparse' radio button (circled), 'L - Area Side' (4), 'K parameter' (0.5), 'Initial K' (0), 'Final K' (1), and 'Step' (0.1). It also includes formulas: $n = \sqrt{L}$ and $r = k^{3/4} \sqrt{\log_2(L)}$.
- Execution Controls:** Includes 'Giant Component' (checkbox checked), 'Node Degree Ratio' (checkbox unchecked), 'Num Topologies' (100), 'Area Side' (100), and an 'Update CTR' button.
- Other options:** Includes 'MST' (checkbox checked), 'Sum of Edges', and a 'Save Neighborhoods' button.

Annotations with arrows point to specific elements:

- 'Description of Dense Topologies for Giant Component Experiment' points to the 'Dense' radio button.
- 'Description of Sparse Topologies for proof of Sparse CTR' points to the 'Sparse' radio button.
- 'Start execution of Giant Component Experiment with the selected description' points to the 'Giant Component' checkbox.
- 'Creates a Minimal Spanning Tree on a topology' points to the 'MST' checkbox.
- 'Selection of topology descriptor for Giant Component Experiment' points to the 'Dense' and 'Sparse' radio buttons.
- 'Updates CTR values in both description panels' points to the 'Update CTR' button.
- 'Save neighborhoods of nodes' points to the 'Save Neighborhoods' button.

Definition of Parameters

Definition of parameter for GC test

Area: 500x500mts, 100 topologies, 200 nodes,
Initial radius: 1% of the area side (5mts),
Increment ratio: 2% of the area side on each
step

- Define all the parameters for the experiment
- Click on the **Giant Component** button. A dialog window will appear asking for the destination folder. In this folder, Atarraya will create an individual folder that will contain the number of requested topologies and will start with the process
- Atarraya will notify the user once the process is finished, i.e., when all the tested topologies are connected

Deployment Options Atarraya Visualization Node Stats Report TC Theoretical

CTR Dense Topologies

Dense

200 Num Nodes 0.01 Initial CTR CTR Penrose-Santi
0.02 CTR Step CTR Santi and Blough
Current: 0

CTR Sparse Topologies - Experiment 3 for 2 dimensions

Sparse

L - Area Side K parameter

4 Initial i 0.5 Initial K CTR Pensore-Santi
10 Final i 1 Final K 0
L=2^(2*i) 0.1 Step 0
n = sqrt(l)
r = k*l^(3/4)*sqrt(log2(l))

Giant Component 100 Num Topologies Update CTR
Node Degree Ratio 500 Area Side

Progress

Other options

MST Sum of Edges: Save Neighborhoods
BFS
Save positions

Experiment I-a

- The results will be stored in a CSV file (comma separated values), readable by most mathematical analysis software (Excel in the example)
- The columns in the results file are
 - Communication radius tested
 - Average size of the greatest component
 - Percentage of connected topologies
 - Average node degree
- The figure of the experiment looks like this

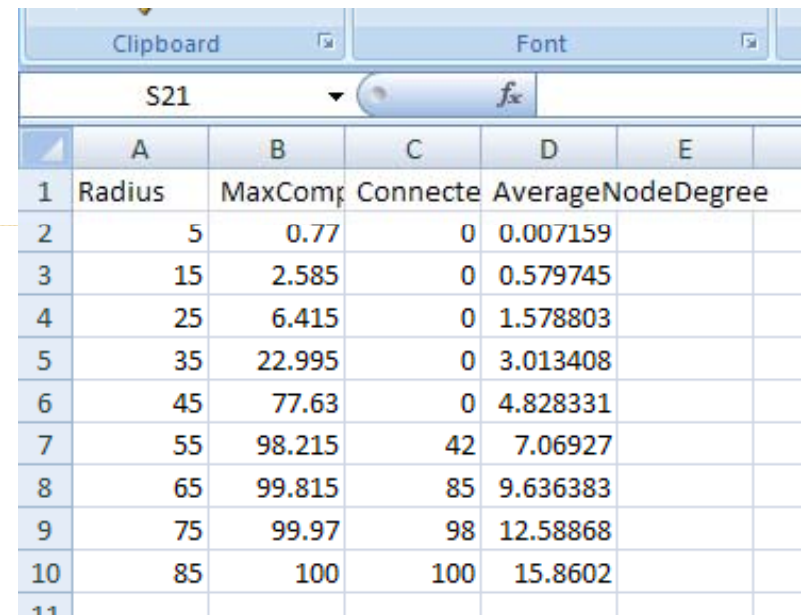

	A	B	C	D	E
1	Radius	MaxComp	Connecte	AverageNodeDegree	
2	5	0.77	0	0.007159	
3	15	2.585	0	0.579745	
4	25	6.415	0	1.578803	
5	35	22.995	0	3.013408	
6	45	77.63	0	4.828331	
7	55	98.215	42	7.06927	
8	65	99.815	85	9.636383	
9	75	99.97	98	12.58868	
10	85	100	100	15.8602	
11					

Experiment I-a – GC, CT, and ND

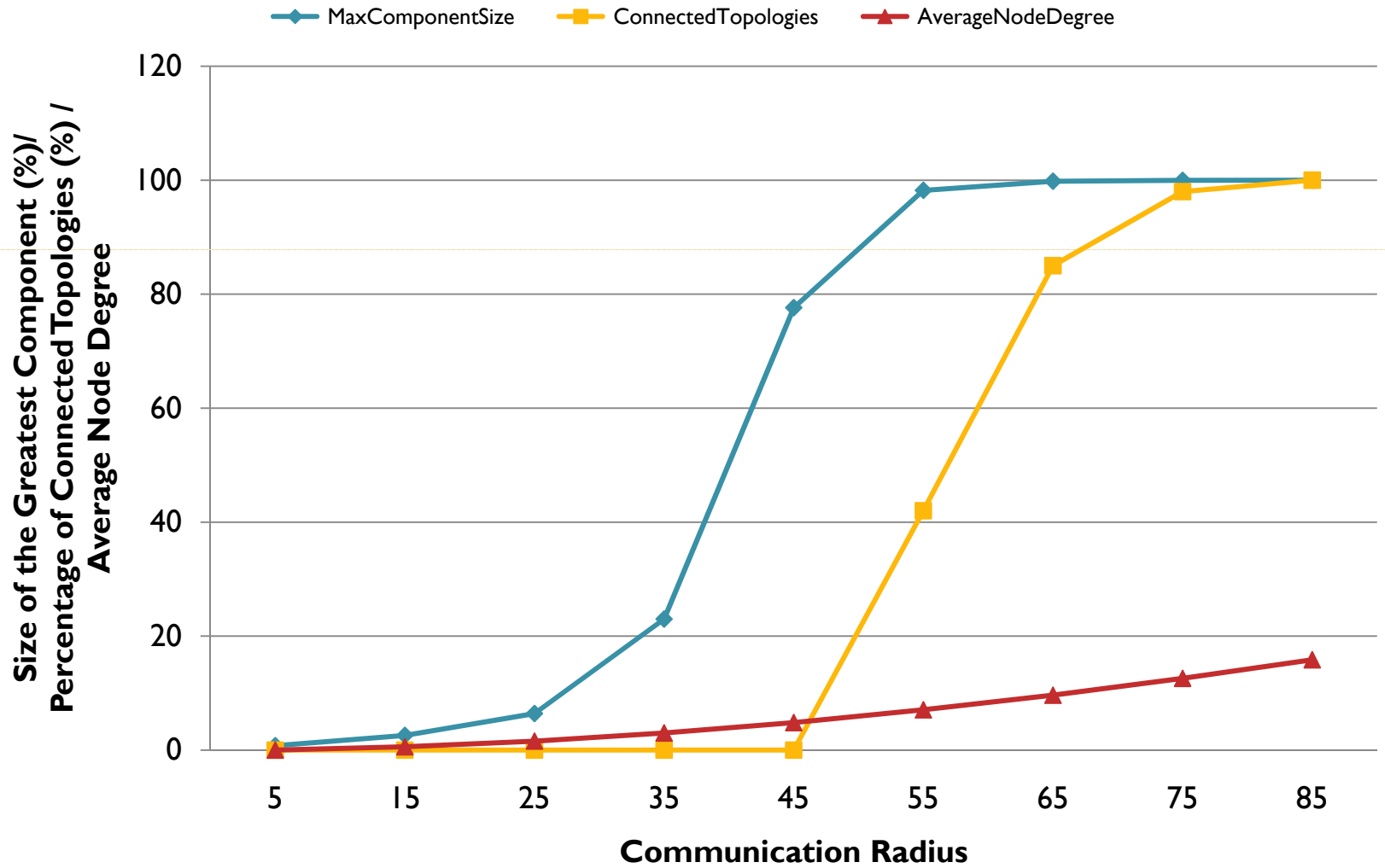

Experiment I-a

- Other example
 - Area 100mx100m
 - 10,100 and 1000 nodes
 - 1000 random topologies

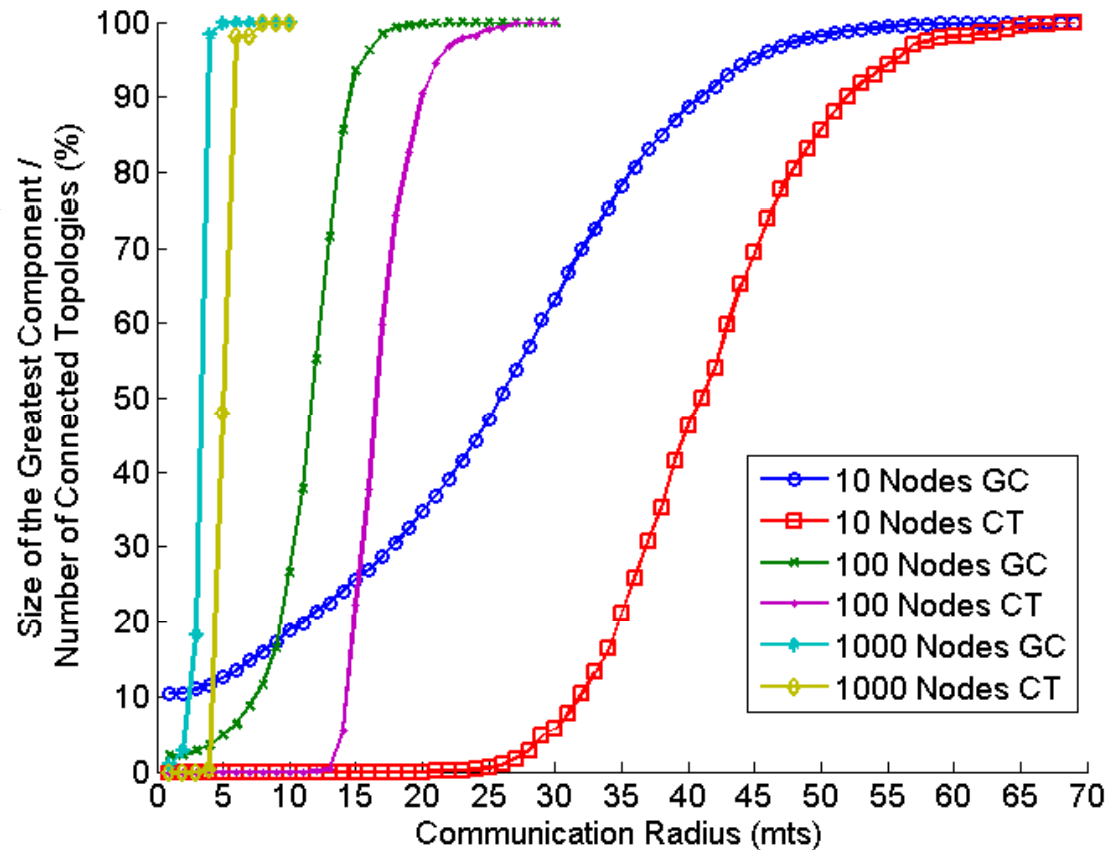

Critical Transmission Range

- Penrose's formula does not provide a very accurate radius
 - For very dense topologies (1000 nodes) the CTR always works
 - **Only 2 times the CTR provides a radius with total connectivity for all topologies**

Number of CTRs	Number of Nodes	Theoretical CTR (Equation 7.1)	Giant Component (Simulations)	Connected Topologies Simulations
1xCTR	10	31.59	69.87	10.30
	100	13.97	85.69	5.40
	1000	5.30	99.99	98.10
1.5xCTR	10	47.38	97.36	80.50
	100	20.95	99.88	94.50
	1000	7.95	99.90	99.80
2xCTR	10	63.18	99.90	99.00
	100	27.94	99.90	99.80
	1000	10.6	100.00	100.00

GC for Sparse Topologies

- Atarraya also offers a similar tool for testing the greatest component in *sparse topologies*, defined by Santi and Boloug as

$$n = \sqrt{l}$$

$$r_{comm} = k \cdot l^{3/4} \cdot \sqrt{\log_2 l}$$

$$0.5 \leq k \leq 1$$

- The number of nodes and the communication radius depend only on the area side l
- This experiment is the replicate of the one used by the authors to demonstrate the high level of connectivity ratio produced by their definition



GC for Sparse Topologies

- The curve seen on the classic experiment will not be seen in the results because the definition of this particular kind of networks guarantees a high level of connectivity
-
- In the results of this experiment, it will be seen that the parameter k is the one that determines the level of connectivity

Experiment I-b

- Area
 - The area is calculated using this formula: $2^{(2*i)}mts$
 - Initial value of i : 4 (area = 256mts)
 - Final value of i : 10 (area = 1048.576 Kms, 1,048,576 mts)
- Value of parameter k
 - Initial k : 0.5
 - Final k : 1
 - Changing ratio of parameter k : 0.1
- Evaluation on 100 random topologies
- Number of nodes calculated according to the formula
- Communication radius calculated according to the formula
- Results
 - Average size of the greatest component
 - Percentage of connected topologies
 - Average node degree

Definition of Parameters

Definition of parameter for GC test

Initial value of i: 4, Final value of i: 10, Initial k: 0.5, Final k: 1, Changing ratio of parameter k: 0.1

- Define all the parameters for the experiment
- Click on the **Giant Component** button. A dialog window will appear asking for the destination folder. In this folder, Atarraya will save the results of the test. Atarraya does not store the tested topologies in this experiment
- Atarraya will notify the user once the process is finished, i.e., when all the tested topologies are connected

Deployment Options | Atarraya | Visualization | Node Stats | Report | TC Theoretical

CTR Dense Topologies

Dense

100 Num Nodes 0.01 Initial CTR CTR Penrose-Santi
0.01 CTR Step CTR Santi and Blough
0

Current:

CTR Sparse Topologies - Experiment 3 for 2 dimensions

Sparse

L - Area Side K parameter

4 Initial i 0.5 Initial K CTR Pensore-Santi
10 Final i 1 Final K CTR Santi and Blough
L=2^(2*i) 0.1 Step 0
n = sqrt(l)
r = k*i^(3/4)*sqrt(log2(l))

Giant Component 100 Num Topologies Update CTR

Node Degree Ratio 100 Area Side

Progress

Other options

MST Sum of Edges: Save Neighborhoods
BFS
Save positions

Experiment I-b GC

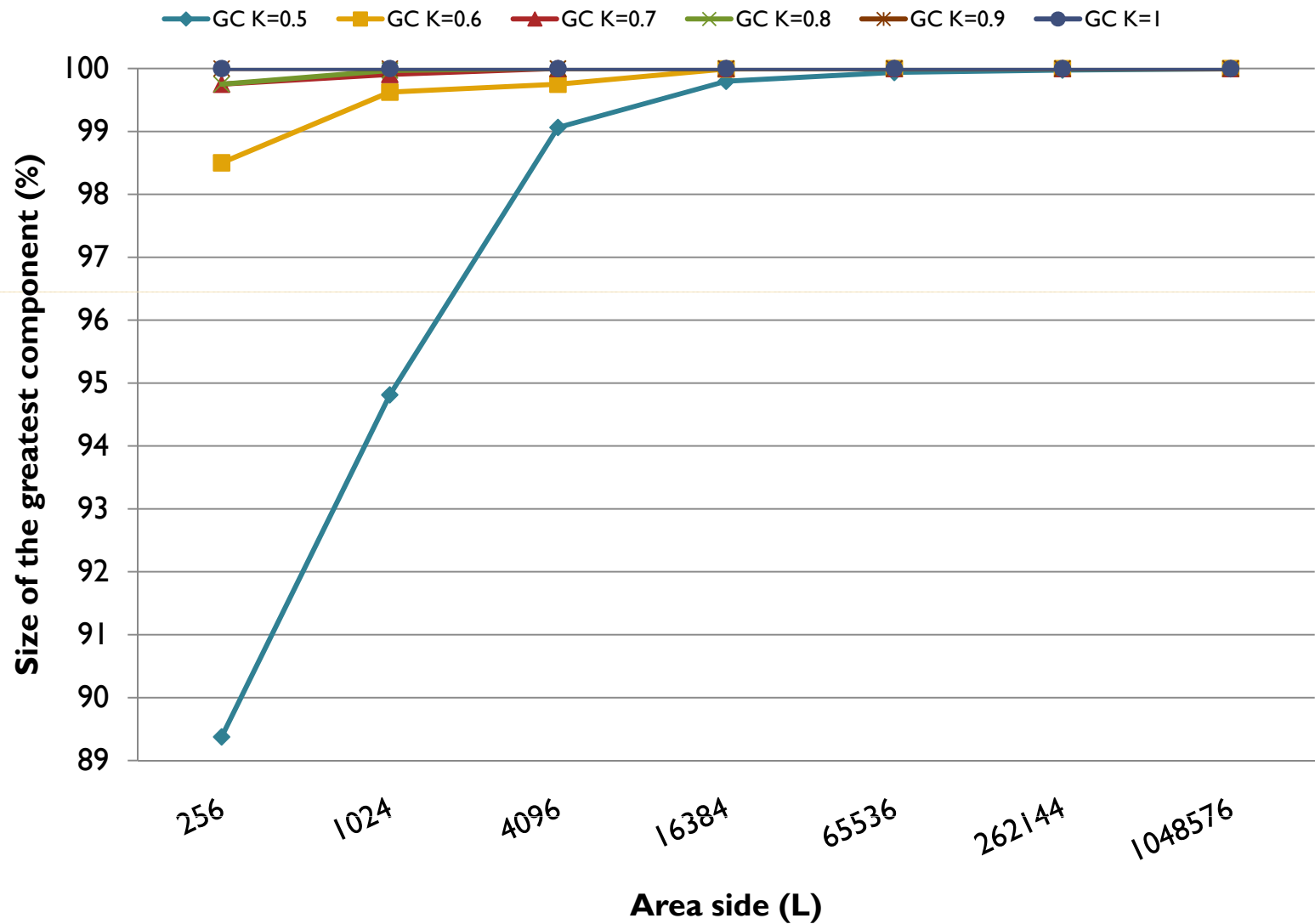

Experiment I-b CT

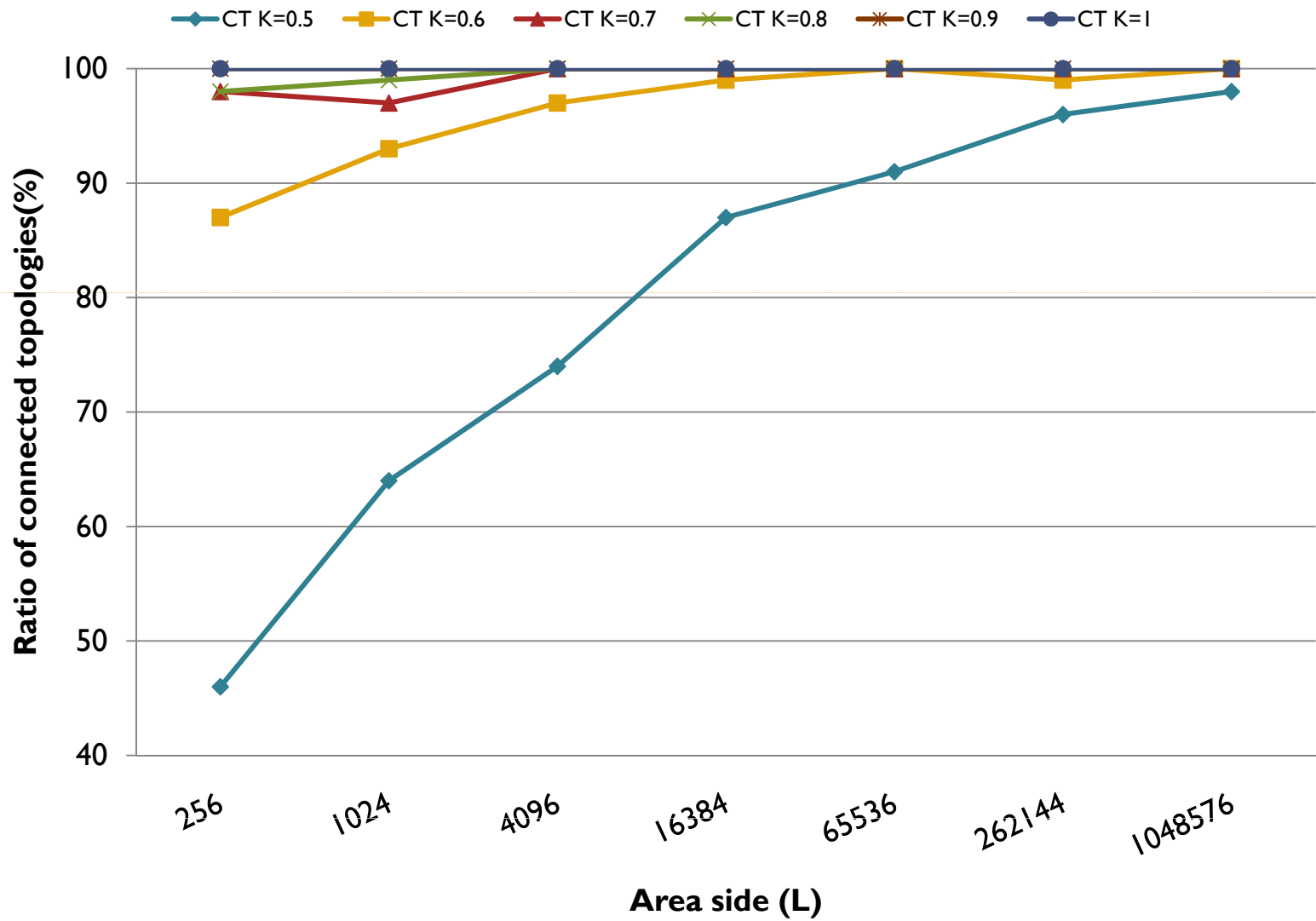

Experiment I-b Node Degree

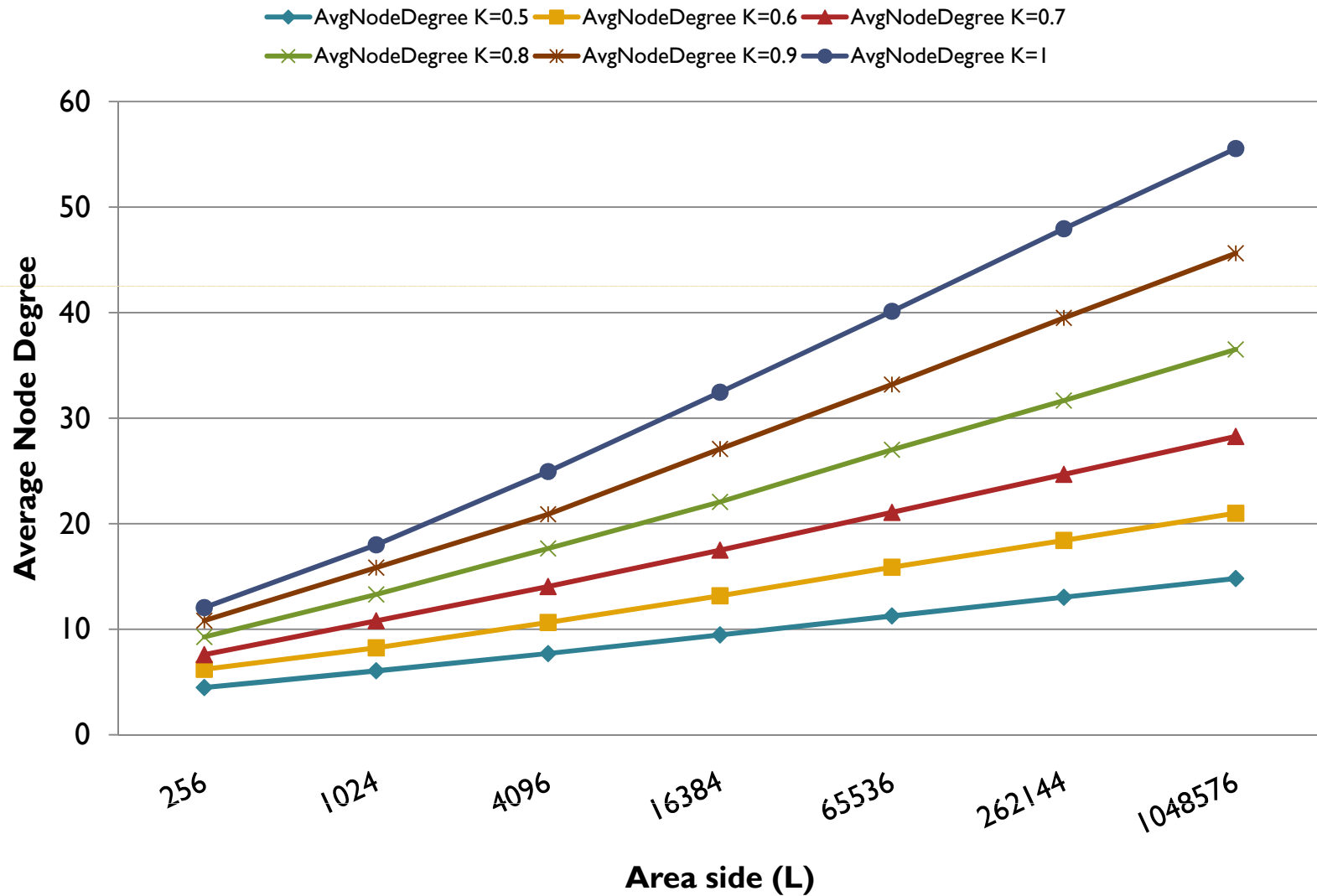



Results with Sparse Topologies

- The results show an improvement in terms of connectivity on the Sparse CTR when compared to the Dense CTR
 - Mainly because it designs the parameters of the network
 - This formula for CTR may not fit a general scenario that does not obey the calculated parameters
- In scenarios with small area side l , the radius tends to be very large and almost equal to l , which may not bring enough savings



Range Assignment Problem

- The CTR problem assign a common radius to every node, which could be very large
 - This solution may not providing enough savings if most of the nodes need a smaller range
- The Range Assignment Problem assigns the minimum radius to each node, while preserving connectivity
 - Optimal Tx range for each node
 - Localization of the nodes is needed
 - NP-Hard problem for 2 and 3 dimensions, not feasible for large networks
 - MST is a 2-approximation of the RA problem



Tx-Range-based Topology Construction

- Many approximation algorithms have been proposed to solve this problem:
 - Geometry-based solutions
 - Location-based
 - Orientation-based
 - Neighbor-based
 - Routing-based

Tx-Range-based Topology Construction

- Geometry-based and Location-based solutions
 - All nodes know their position
 - Examples: Relative Neighbor Graph - RNG, Gabriel Graph - GG, Local Minimal Spanning Tree - LMST

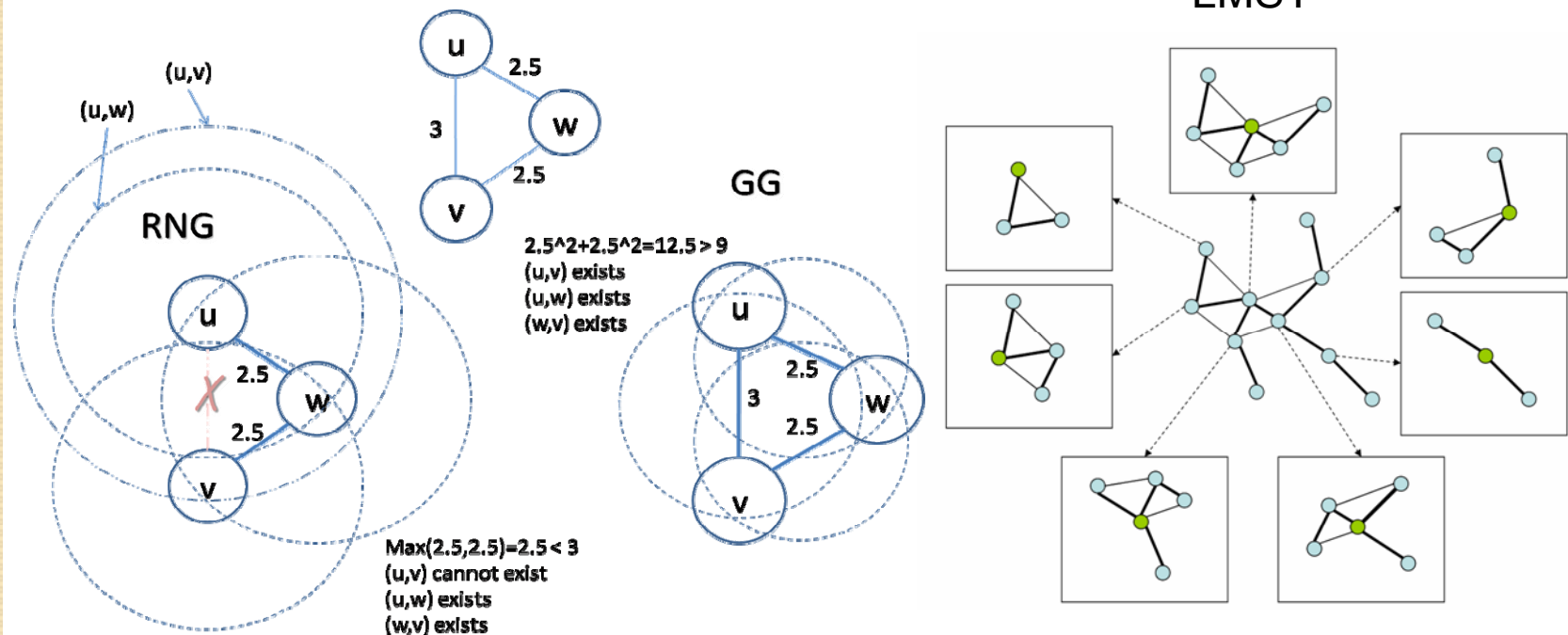

Tx-Range-based Topology Construction

- Neighbor-based solutions
 - Nodes do not know their position; they just calculate the distance between itself and its neighbors
 - Theoretical approach is based on a function based on n . The authors say that *w.h.p.*, the k from the function will return a connected topology
 - In the figure it is shown how the connectivity of 90% and 100% are associated with different values of c in topologies with difference sizes
 - **Connectivity is not guaranteed!**

(value of c , number of neighbors)

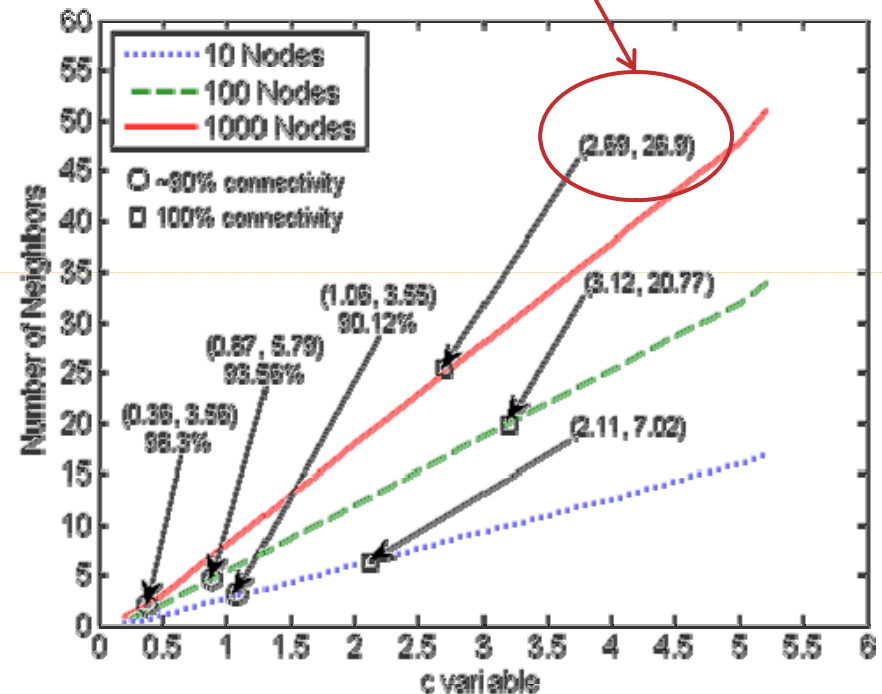

$$k = c \log n$$

$$0.074 < c < 5.1774 + \varepsilon$$

$$\varepsilon > 0$$

Tx-Range-based Topology Construction

- Neighbor-based solutions
 - Examples of distributed solutions: K-Neigh, K-NeighLev, XTC

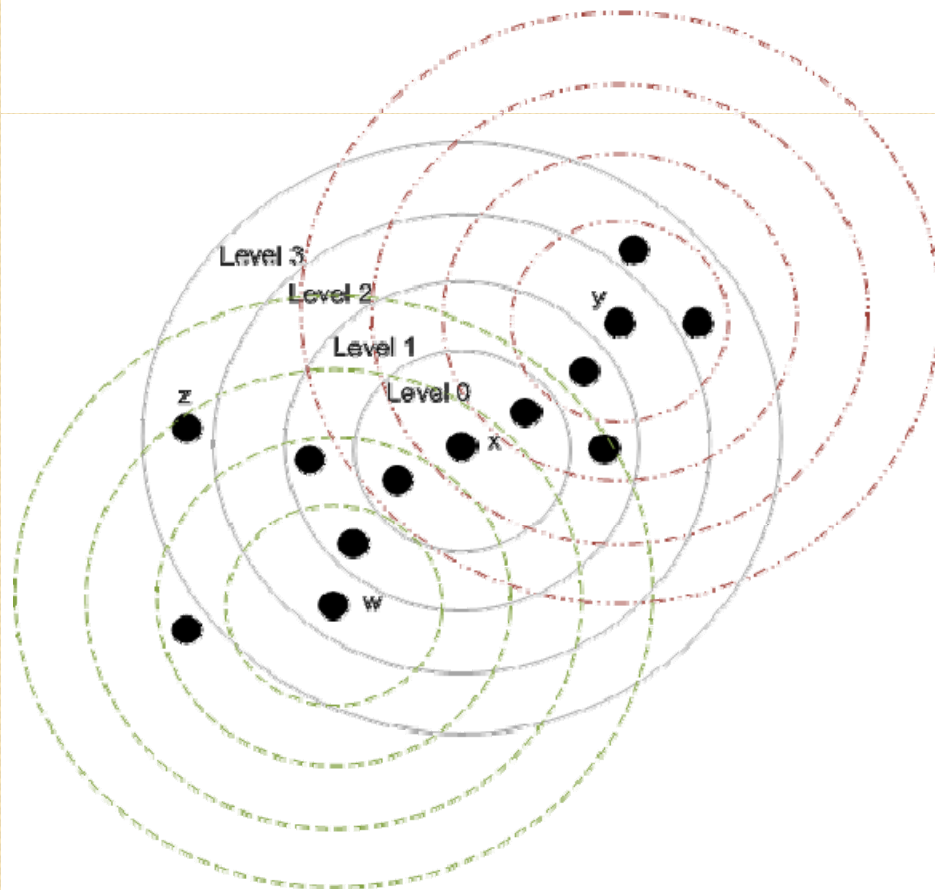

K-NeighLev: Each node chooses the TX level that gives them at least k neighbors. This scheme does not guarantee connectivity

K-Neigh, which assumes continuous communication range, and defines it until it reaches k neighbors, is offered in Atarraya

Hierarchy-based Topology Construction

- CDS-based solutions
 - Creating a backbone that supports communication. Also, the nodes that are not part of the backbone can be turned off
- Grow a Tree: A3
 - Start at one point and add new nodes to the existing tree (like in Prim's algorithm)
- MIS based: EECDS
 - Find the maximum number of independent nodes(which do not share links)
 - Select extra nodes that will connect them
- Pruning based: CDS Rule K
 - Discard nodes whose neighbors form a connected graph (there is a path between any pair of nodes)
 - Discard all nodes whose neighbors are covered by other active nodes with higher priority (priority pre-assigned)

Hierarchy-based Topology Construction

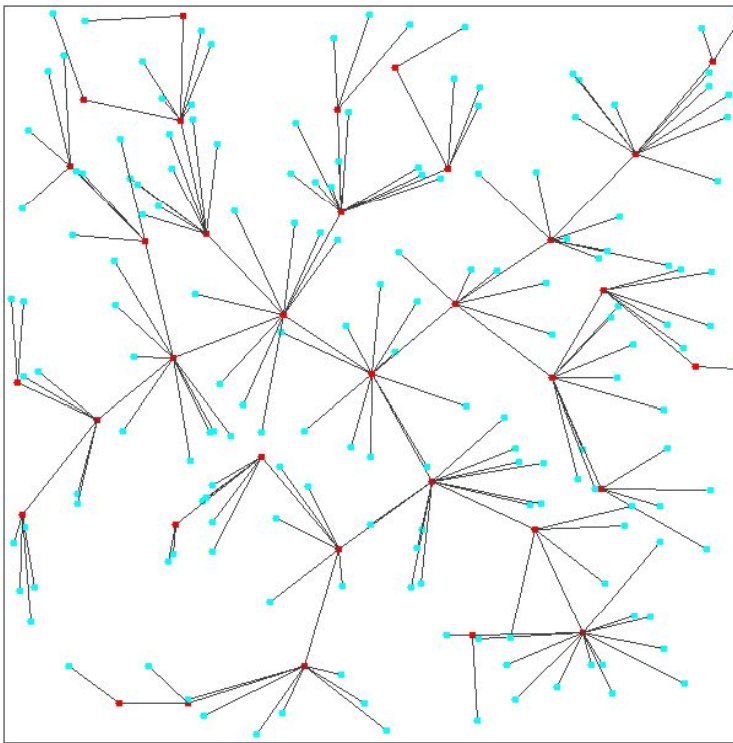

A3

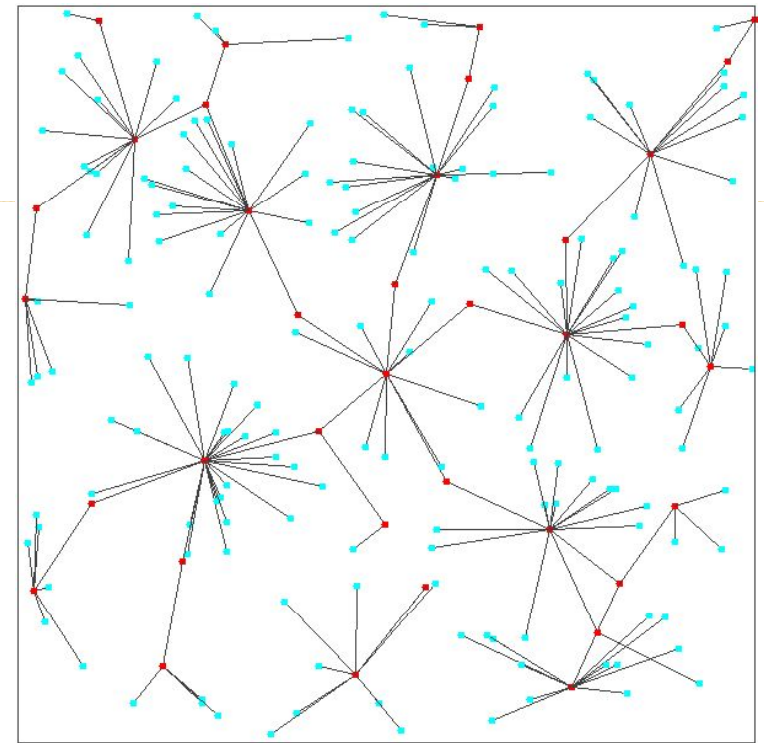

EECDS

Hierarchy-based Topology Construction

- Cluster-based solutions
 - Create cluster of nodes, organized by cluster heads
 - 1 Hop Clusters: All cluster heads are 1-hop away from the sink: LEACH
 - Multiple Hop Clusters: Cluster heads can be more than 1-hop away from the sink: HEED

LEACH

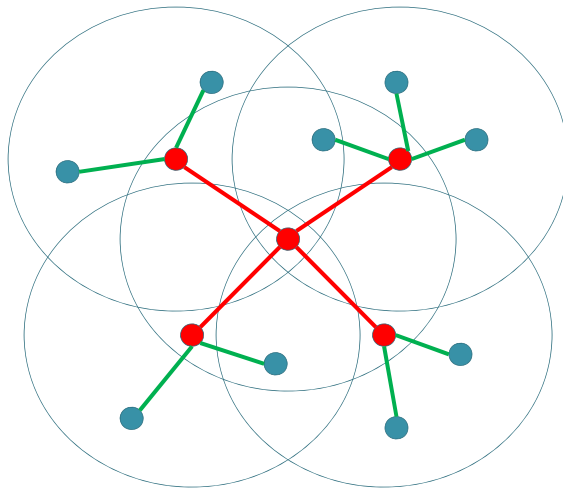

HEED

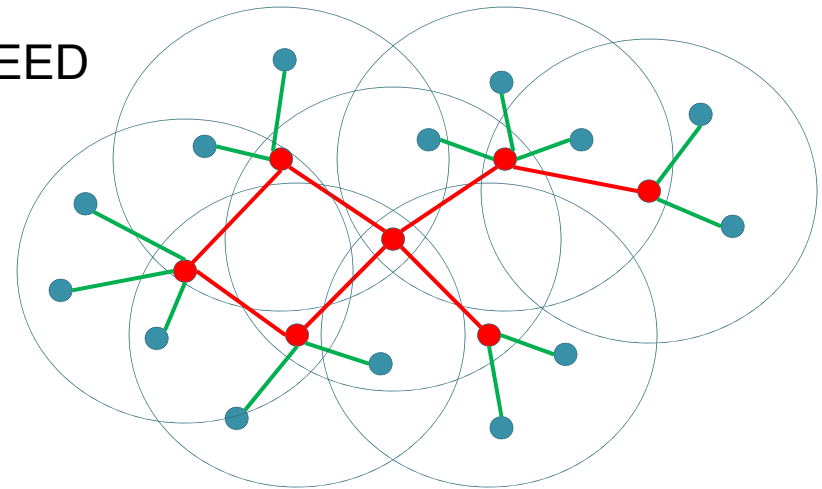



**EXPERIMENTS
PART II –
TOPOLOGY
CONSTRUCTION**

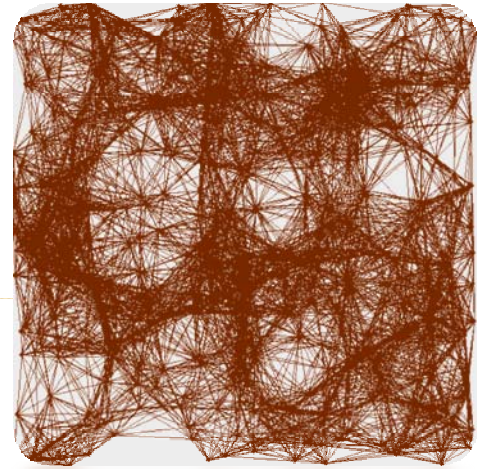



Experiments

- Experiment II-a
 - No topology construction, no topology maintenance
 - Experiment II-b
 - Topology Construction for connectivity
-



Introduction

- The process to do an experiment in Atarraya is the following:
 - Define the parameters and generate the topology
 - Select the protocols
 - Run the experiment
 - Collect statistics

Experiment II-a

Default Topology, No Topology Control

- Area: 600 x 600mts
- Nodes
 - 100 nodes, distributed uniformly in the area, 1000 mJ of energy constant
 - A single sink node in the center of the area
 - Communication radius = 100mts
 - Sensing radius = 20mts
- Protocols
 - Topology Construction: JustTree (No topology construction)
 - Topology Maintenance: Non Isolated Sink (No topology maintenance)
- Results
 - Performance stats
 - Lifetime evaluation



Deployment Generation

- The first window that Atarraya shows is the deployment or topology generation

- In the same window, you create the initial deployment of the network
 - In the experiment of part II, the default parameters will be used to create a random topology

Deployment Generation

- You need to define the following parameters:
 - Number of nodes
 - How many nodes? How many sinks? Are all nodes the same?
 - Radius of communication and sensing
 - Distribution of the nodes: random distribution for position
 - Uniform, normal, grid HV, grid HVD, etc.
 - Deployment area
 - Size of the deployment area as a rectangle. (H, W)
 - Bit error rate
 - Energy distribution
 - Initial energy on the nodes, on mJ (Joules x 10^{-3}). Uniform, normal, constant and Poison.

Note: IDs of the sinks will be from the number of regular nodes up. For example: if there are 100 nodes, and 1 sink, the ID of the sink will be 100, and the IDs of the other nodes will be from 0 to 99.

Deployment Generation

The screenshot shows a software window titled "Deployment Generation" with several tabs: "Deployment Options", "Atarraya", "Visualization", "Node Stats", "Report", and "TC Theoretical". The "Deployment Options" tab is active, showing two sub-tabs: "Deployment" and "Other Params.". The "Deployment" sub-tab contains the following sections:

- Deployment:** Includes input fields for "# Nodes" (1000), "Comm Radius" (40), and "Sensing Radius" (20). It also has a checkbox for "Sink?" and a dropdown for "Infrastructure Association" (set to "Block").
- Deployment Visibility Area:** Includes input fields for "Width" (600) and "Height" (600), and a "BIT Error Rate" field.
- Node Location Distribution:** Includes a dropdown set to "Uniform", and input fields for "Width" (600), "Height" (600), "X" (300), and "Y" (300). It also has a "Sigma" field and a "Manual Pos." button.
- Node Energy Distribution:** Includes a dropdown set to "Constant", and input fields for "Max" (1000) and "Mean" (5). It also has a "Sigma" field.
- Node Creation List:** An empty text area for listing node creation words.
- Sink Creation List:** An empty text area for listing sink creation words.
- Batch Creation:** Includes a checkbox for "Batch Creation", a "# of Topologies" field (set to 1), and an "Index start in:" field (set to 0). It also has a "Progress:" field and a checked checkbox for "Check Max. Trials".
- Controls:** Includes "Add", "Remove", and "Clear" buttons.
- Deployment Creation:** Includes a "Create Deployment" button and two checked checkboxes: "Generate Deployment?" and "Check Connectivity Exhaustively".

Annotations on the left side of the interface:

- Deployment size, transmission and sensing radius of range
- Size of deployment area
- Deployment Location Distribution
- List of node creation words
- List of sink creation words
- Controls for creation/removal of creation words.
- Deployment Creation button

Annotations on the right side of the interface:

- Sink related variables
- Bit error rate on the deployment area
- Deployment Energy Distribution
- Panel for multiple deployments creation, or Batch Creation
- Switch between update parameter or create the actual deployment
- Option to generate only connected deployments

Deployment Generation

Deployment area's size definition

$Area = 600 \times 600$

This area will be represented by the square that surrounds the topology

Definition of nodes

100 nodes, distributed uniformly in an area of 600x600 with center in (300,300), 1000 mJ of energy constant

1 sink node in the center of the deployment area

•When using the default values, no changes need to be done on the parameters

•To generate the default topology, just click on the **Create Deployment button**

Deployment Options | Atarraya | Visualization | Node Stats | Report | TC Theoretical

Deployment | Other Params.

Deployment

# Nodes	Comm Radius	Sensing Radius
100	100	20

Infrastructure Association: Sink? Black

Deployment Visibility Area

Width	Height	Bit Error Rate
600	0	

Node Location Distribution

Uniform | 600 | Width | 600 | Height

300 X 300 Y 5 Sigma Manual Pos.

Node Energy Distribution

Constant | 1000 | Max | 1000 | Mean | 5 | Sigma

Node Creation List

Sink Creation List

Batch Creation

Batch Creation

1 # of Topologies

0 Index start in:

Progress:

Check Max. Trials

Add Remove Clear

Create Deployment Generate Deployment? Check Connectivity Exhaustively

Deployment Generation

- Once the **Create Deployment** button is pressed, we obtain this topology, and we change to the **Atarraya** tab

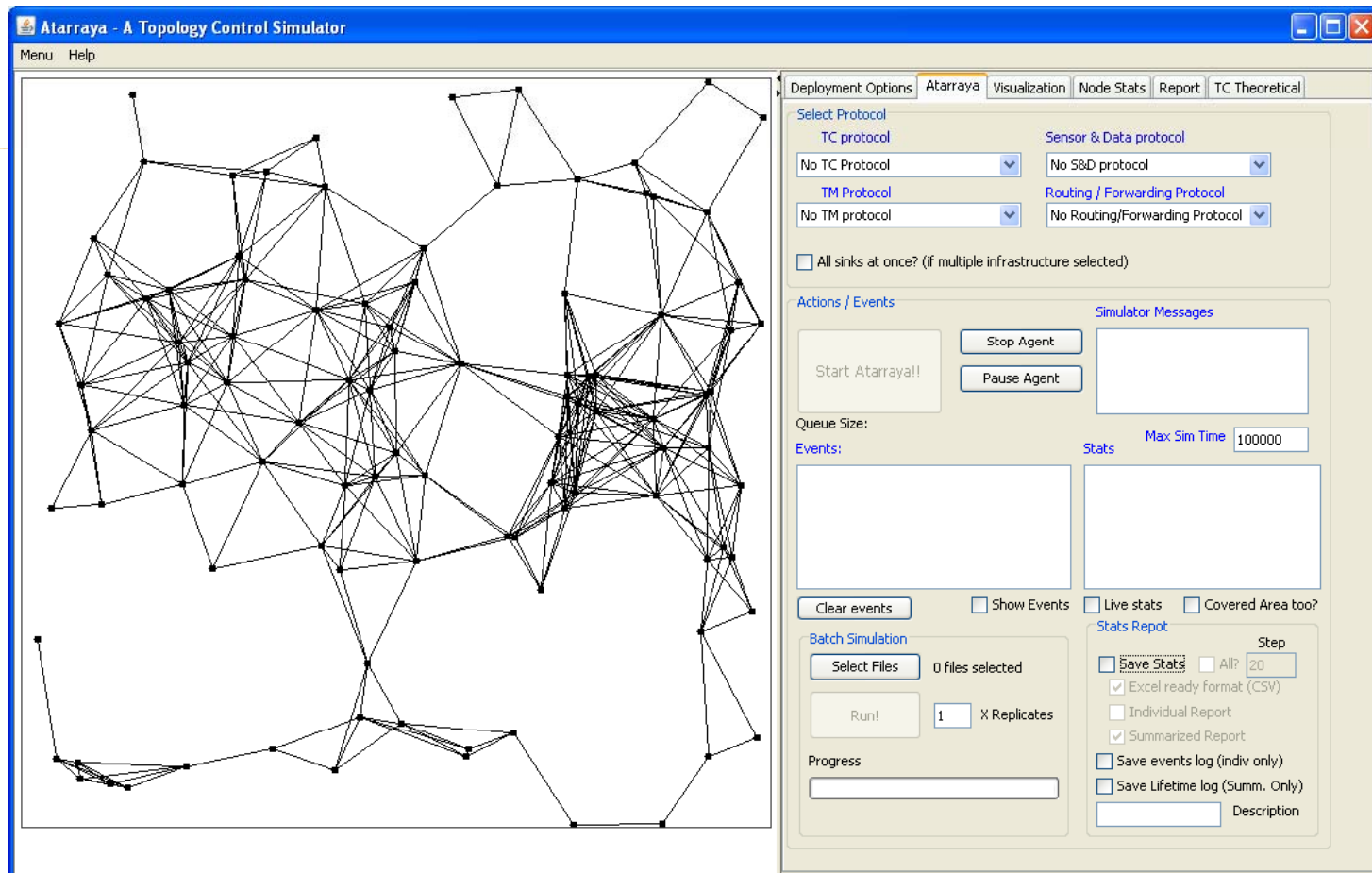

The screenshot displays the Atarraya - A Topology Control Simulator interface. The main window shows a complex network topology with numerous nodes and connections. The interface includes a menu bar (Menu, Help) and a toolbar with tabs for Deployment Options, Atarraya, Visualization, Node Stats, Report, and TC Theoretical. The Atarraya tab is active, showing various configuration options:

- Select Protocol:** TC protocol (No TC Protocol), Sensor & Data protocol (No S&D protocol), TM Protocol (No TM protocol), Routing / Forwarding Protocol (No Routing/Forwarding Protocol).
- All sinks at once? (if multiple infrastructure selected)
- Actions / Events:** Start Atarraya!, Stop Agent, Pause Agent.
- Queue Size:** [Empty field]
- Events:** [Empty field]
- Stats:** Max Sim Time 100000.
- Clear events, Show Events, Live stats, Covered Area too?
- Batch Simulation:** Select Files (0 files selected), Run! (1 X Replicates).
- Stats Report:** Save Stats (Step: All, 20), Excel ready format (CSV), Individual Report, Summarized Report, Save events log (indiv only), Save Lifetime log (Summ. Only), [Empty field] Description.

Protocol Selection

- On the Atarraya tab, the user is able to:
 - Select the protocols
 - Control del execution of the simulation
 - Watch all simulation events (not recommendable or long simulations – require a lot of memory)
 - Obtain live statistics
 - Run batch simulation (multiple topologies)
 - Define results parameters

Protocol Selection

The screenshot shows the 'Atarraya' software interface with several tabs: 'Deployment Options', 'Atarraya', 'Visualization', 'Node Stats', 'Report', and 'TC Theoretical'. The 'Atarraya' tab is active, displaying the following sections:

- Select Protocol:** Includes dropdown menus for 'TC protocol' (set to 'No TC Protocol'), 'Sensor & Data protocol' (set to 'No S&D protocol'), 'TM Protocol' (set to 'No TM protocol'), and 'Routing / Forwarding Protocol' (set to 'No Routing/Forwarding Protocol').
- Parallel start of multiple infrastructures:** A checkbox labeled 'All sinks at once? (if multiple infrastructure selected)'.
- Actions / Events:** Contains buttons for 'Start Atarraya!', 'Stop Agent', and 'Pause Agent'.
- Simulator Messages:** A text area for displaying simulation messages.
- Simulation Events panel:** A large text area for displaying simulation events, with a 'Clear events' button and a 'Show Events' checkbox.
- Simulation Statistics panel:** A text area for displaying simulation statistics, with 'Live stats' and 'Covered Area too?' checkboxes.
- Batch Simulation:** Includes a 'Select Files' button (showing '0 files selected'), a 'Run!' button, a 'Step' input field (set to '1'), and a 'Description' input field.
- Report Design panel:** Includes checkboxes for 'Save Stats', 'Excel ready format (CSV)', 'Individual Report', 'Summarized Report', 'Save events log (indiv only)', and 'Save Lifetime log (Summ. Only)'. A 'Step' input field is also present.

Annotations on the left side of the image point to specific features:

- 'Protocol Selection for the simulation: Topology Constructions, Topology Maintenance, Sensor & Data and Routing/Forwarding protocols.' points to the 'Select Protocol' section.
- 'Parallel start of multiple infrastructures' points to the 'All sinks at once?' checkbox.
- 'Control of the simulation agent: Start, Pause and Stop buttons.' points to the 'Start Atarraya!', 'Stop Agent', and 'Pause Agent' buttons.
- 'Simulation Events panel' points to the 'Events:' text area.
- 'Batch Simulation panel' points to the 'Batch Simulation' section.

Annotations on the right side of the image point to specific panels:

- 'Simulator Messages' points to the 'Simulator Messages' text area.
- 'Simulation Statistics panel' points to the 'Stats' text area.
- 'Report Design panel' points to the 'Stats Report' section.



Protocol Selection

- If you can see, the Start Atarraya button is disabled. It will be enabled when:
- A topology construction protocol is selected (Short Simulation)
 - The simulation will stop after the first execution of the topology construction protocol
- When all protocols have been selected (Long simulation)
 - The simulation will perform a life time experiment, and will stop once the finalization criteria is reached

Protocol Selection

Definition of the protocols

JustTree,, Non Isolated sink, Simple S&D, Simple Forwarding

•Select these protocols on the respective menus. The two last protocols are the only ones of their kind (so far), but they need to be selected in order to enable the simulator to start

Parameters for Statistics

Stats, and Lifetime evaluation

The result's parameters work as:

- To save stats, select the checkbox. Atarraya will generate stats when the topology construction is finished and when the simulation is finished
- The excel-ready format generates CSV files if checked. Otherwise, it will be in human-readable format
- To save lifetime log, select the checkbox
- To save simulation events log, select the checkbox

•Once all parameters are defined, click on the **Start Atarraya button**. DO NOT USE THE RUN BUTTON FOR THIS EXPERIMENT!

The screenshot shows the Atarraya simulator interface with the following sections:

- Deployment Options:** Atarraya, Visualization, Node Stats, Report, TC Theoretical
- Select Protocol:**
 - TC protocol: Just Tree
 - Sensor & Data protocol: Simple S&D protocol
 - TM Protocol: Non Isolated Sink
 - Routing / Forwarding Protocol: Simple Forwarding
- All sinks at once? (if multiple infrastructure selected)
- Actions / Events:**
 - Start Atarraya!! (highlighted with a red box)
 - Stop Agent
 - Pause Agent
- Queue Size:** [Empty field]
- Events:** [Empty field]
- Stats:** Max Sim Time: 100000
- Live stats
- Covered Area too?
- Batch Simulation:**
 - Select Files: 0 files selected
 - Run! [1] X Replicates
- Stats Report:**
 - Save Stats
 - All? Step: 20
 - Excel ready format (CSV)
 - Individual Report
 - Summarized Report
 - Save events log (indiv only)
 - Save Lifetime log (Summ. Only)
- Progress: [Empty field]
- Prueba_tutorial_def Description

Start Simulation

- Once you click on the Start Atarraya button, the simulation will start
 - Given that the topology has not been saved, the simulator will require the user to specify the directory where the result files will be saved
 - If the experiment is being run using an existing topology from a file, then the results will be stored in the same directory as the topology file
- You can tell that the simulation started when the simulation clock, the number of events and the queue size start to flicker
- If you want to see all the event that will happen on the simulation, you can click on the **Show events** check box

Simulation Control

Atarraya - A Topology Control Simulator

Menu Help

Deployment Options Atarraya Visualization Node Stats Report TC Theoretical

Select Protocol

TC protocol

Just Tree

TM Protocol

Non Isolated Sink

Sensor & Data protocol

Simple S&D protocol

Routing / Forwarding Protocol

Simple Forwarding

All sinks at once? (if multiple infrastructure selected)

Actions / Events

Start Atarraya!!

Stop Agent

Pause Agent

Queue Size: 233

Events: 142168 Clock: 412.99056287722834

Max Sim Time 100000

Simulation Control buttons:

- Stop Simulations
- Pause/Resume simulation

Simulation clock, Number of event and Queue size

Clear events

Show Events Live stats Covered Area too?

Batch Simulation

Select Files 0 files selected

Run! 1 X Replicates

Progress

Stats report

Save Stats All? 20

Excel ready format (CSV)

Individual Report

Summarized Report

Save events log (indiv only)

Save Lifetime log (Summ. Only)

Prueba_tutorial_def Description

Show events and stats during execution.

Simulation

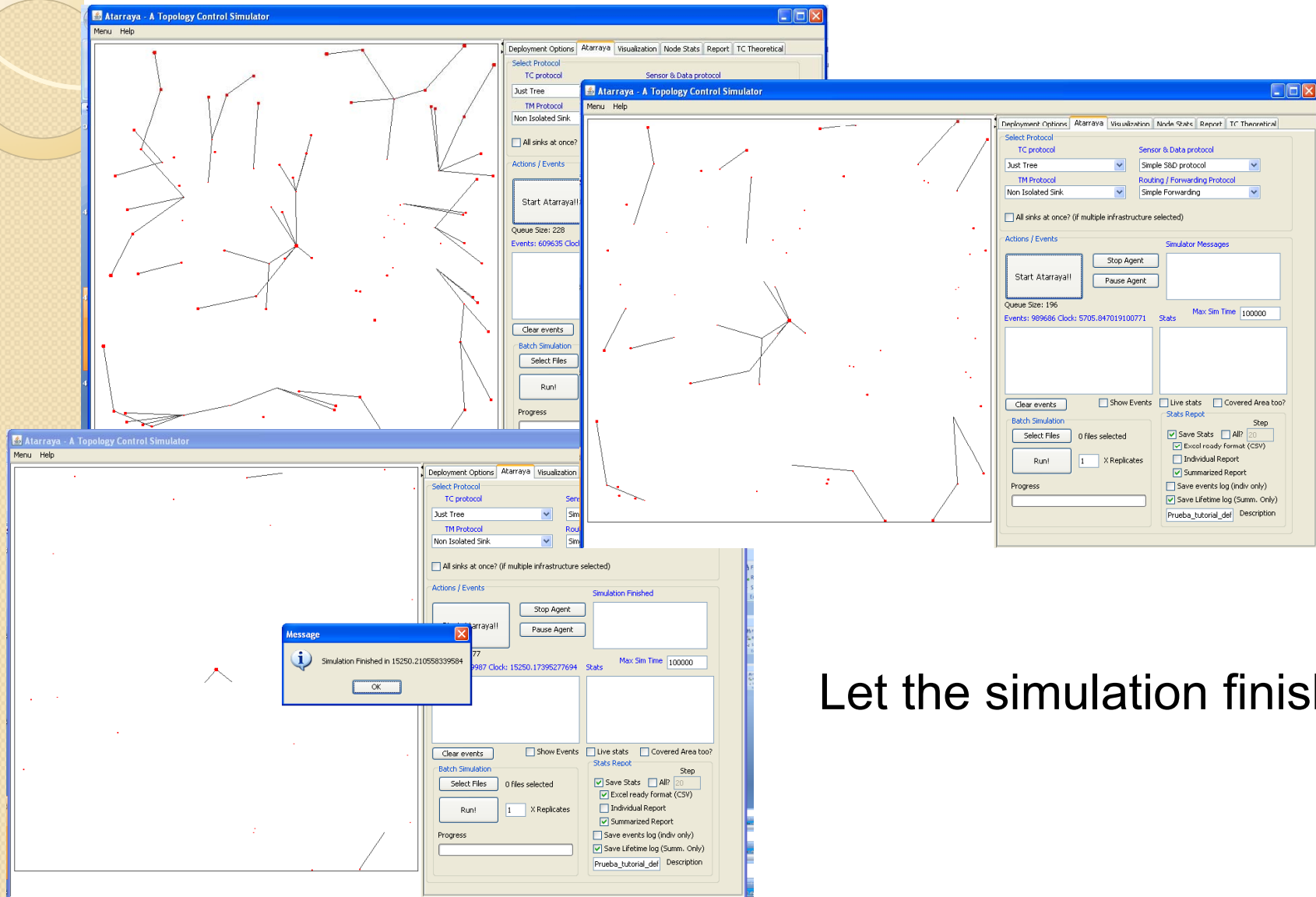

Let the simulation finish!

Simulation Results

- Once the simulation finished, you are able to find the results: Statistics and Lifetime
 - stats_prueba_tutorial_default_20_4_2009@15_9_21.csv
 - lifetime_prueba_tutorial_default_20_4_2009@15_9_21.csv
- The filenames include
 - The type of information they contain
 - The date and time when they were generated
 - Any identifier text defined on the stats panel (in this case, prueba_tutorial_default)
- The Comma Separated Values (CSV) formatted files can be opened directly on MS Excel, or loaded into Matlab or other data analysis software

Simulation Results

Information on the stats file, as it can be seen in the stats window in Atarraya (in not cvs format)

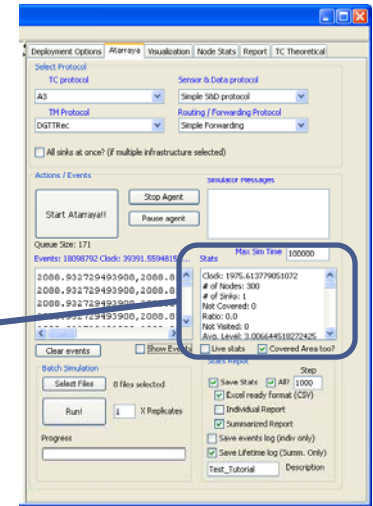

- Clock: 15250.210558339584
- # of Nodes: 100
- # of Sinks: 1
- Not Covered: 0
- Ratio: 0.0
- Not Visited: 0
- Avg. Level: 3.5742574257425743
- Avg. Num. Neighb.: 8.158415841584159
- Reachable. Num. Active Neighb. from Sink: 6
- # of Messages regular sent: 372
- # of Messages long sent: 170000
- # of Messages regular received: 2688
- # of Messages long received: 1067779
- # of Lost Messages regular: 0
- # of Lost Messages long: 0
- # of Data Messages received by sink: 19045
- # of dead nodes: 62
- # of unconnected nodes: 90
- Real Parents in Tree 0 =39
- Real Parents in Tree 1 =0
- Real Parents in Tree 2 =0
- Real Parents in Tree 3 =0
- Real Parents in Tree 4 =0
- Total Energy initial=101000.0
- Total Energy final=9477.030886365525
- Total Energy spent=92290.79353702655
- Total Energy spent ratio=0.9061680110260839
- Total Energy in tree=8863.76149996266
- Ratio Energy=0.9352888690818592
- Covered Comm Area=0.9571388888888889
- Covered Sensing Area=0.118761111111111111
- Error in simulation=no error

Simulation Results

Stats from the example (from the stats file)

Two rows:

- Time when the topology construction protocol finished
- Time when the simulation finished (when the topology maintenance protocol could not continue)

	A	B	C	D	E	F	G	H	I	J	K	L	M	N	O	P	Q	R	S
1	prueba_tu	10.22713	100	1	0	0	0	3.574257	8.158416	1	101	100	0	822	0	0	0	0	0
2	prueba_tu	15250.21	100	1	0	0	0	3.574257	8.158416	1	6	372	170000	2688	1067779	0	0	62	90
3																			
4																			
5																			
6																			
7																			
8																			
9																			
10																			
11																			

Simulation Results

- The lifetime report needs processing in order to change the format of the data
 - The file contains several registers with this information
 - Time of the information
 - Number of nodes alive
 - Number of active nodes
 - Ratio of covered area by the active nodes
 - Each log entry shows when the topology maintenance protocol is invoked, and when a node dies
 - In order to obtain the lifetime figure in terms of time, it is necessary to find the average number of active nodes or coverage, per time slot

This processing is performed in the Reports tab

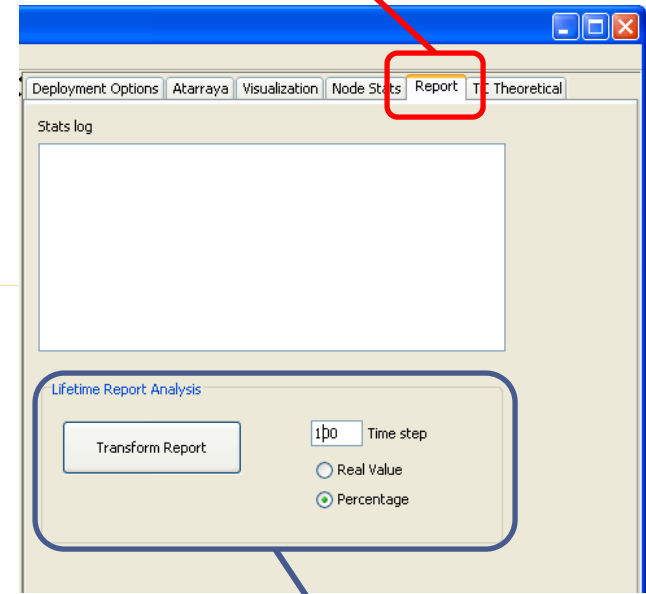

- Real Value: absolute number of nodes
- Percentage: ratio of active nodes over total

Simulation Results

Original lifetime results log

	A	B	C	D	E	F	G	H	I	J	K
1	prueba_tu	16.3664	746.0803	968.7	1145.521	1423.802	1427.648	1581.588	1678.807	2085.87	2341.8
2	prueba_tu	101	100	99	98	97	96	95	94	93	
3	prueba_tu	101	62	62	39	39	21	21	21	21	
4	prueba_tu	1	0.795664	0.795664	0.683306	0.683306	0.499172	0.499172	0.499172	0.499172	0.3175
5	prueba_tu	0.353461	0.229842	0.229842	0.139806	0.139806	0.080853	0.080853	0.080853	0.080853	0.0421
6											

- Time of Evaluation
- Number of nodes alive
- Number of Active Nodes reachable from the sink
- Covered Area for Communication
- Covered Area for Sensing

Summarized lifetime results log

	A	B	C	D
1	0	34	0.966975	0.143769
2	100	34	0.966975	0.143769
3	200	34	0.966975	0.143769
4	300	34	0.966975	0.143769
5	400	34	0.966975	0.143769
6	500	34	0.966975	0.143769
7	600	34	0.966975	0.143769
8	700	34	0.966975	0.143769
9	800	34	0.966975	0.143769
10	900	34	0.966975	0.143769
11	1000	34	0.966975	0.143769
12	1100	34	0.966975	0.143769
13	1200	34	0.966975	0.143769
14	1300	34	0.966975	0.143769

- Time step
- Number of Active Nodes on the time step
- Ratio of covered area for communication on the time step
- Ratio of covered area for sensing on the time step

Simulation Results

Summarized lifetime results figure

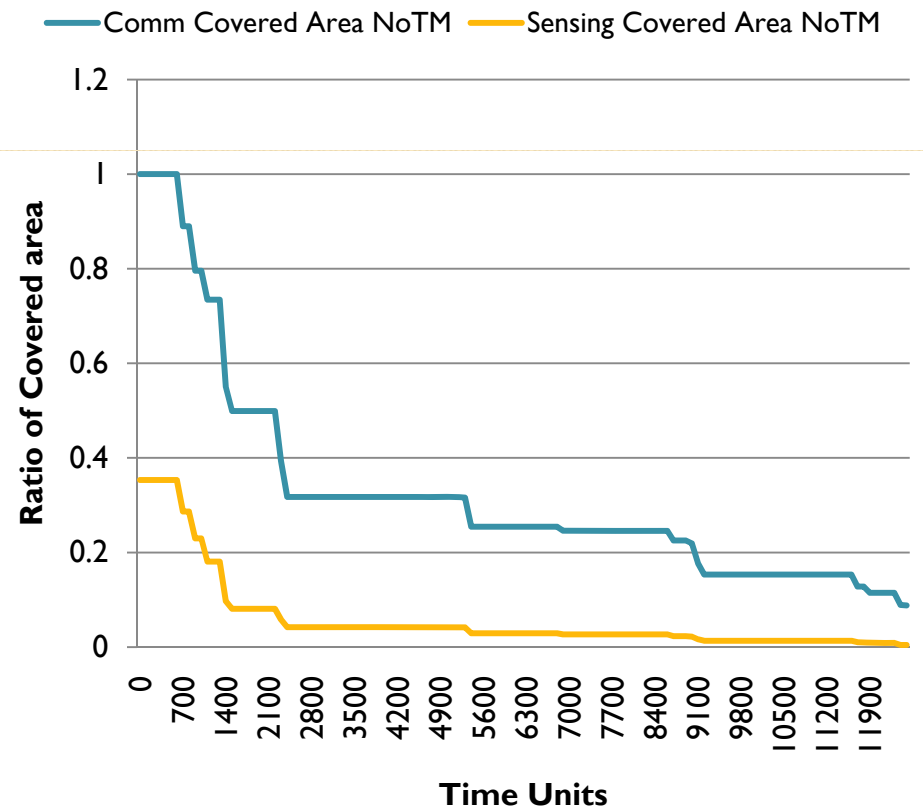
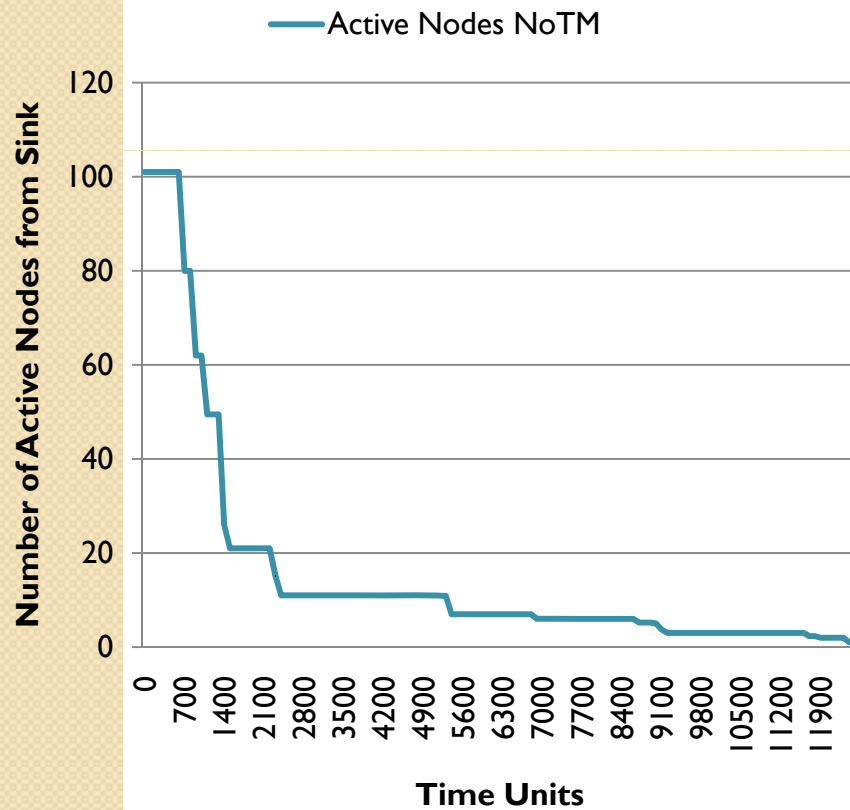

Other Simulation Results

- The visual representation of the topology can offer some information about the experiments
 - Red nodes are active nodes. Light Blue nodes are not selected nodes
- Go to the Visualization Tab and
 - Click on Area Comm. to see the communication coverage
 - Click on Area Sensing to see the sensing coverage
 - Click on Filled Area to see both communication and sensing areas with filled disks
 - Click in Node Id to see the ID of the nodes

Other Simulation Results

The screenshot displays a simulation software interface with three stacked visualization panels. Each panel shows a network graph with nodes and connections, overlaid with a grid. The top panel has a 'Square' grid, the middle panel has a 'Diagonal' grid, and the bottom panel has a 'Diagonal' grid with nodes highlighted in pink circles. The interface includes tabs for 'Deployment Options', 'Atarraya', 'Visualization', 'Node Stats', 'Report', and 'TC Theoretical'. The 'Visualization' tab is active, showing three panels with different grid and node visualizations. Arrows point to specific UI elements with labels: 'Visualization Options' points to the top tabs, 'Draw Grid on Deployment area' points to the 'View Grid' dropdown, and 'General info about the Deployment' points to the 'Deployment Info' section.

Visualization Options

Draw Grid on Deployment area

General info about the Deployment

Panel	View Grid	Area Comm	Area Sensing	Filled Area
Top	Square	<input type="checkbox"/>	<input type="checkbox"/>	<input type="checkbox"/>
Middle	Diagonal	<input checked="" type="checkbox"/>	<input type="checkbox"/>	<input type="checkbox"/>
Bottom	Diagonal	<input checked="" type="checkbox"/>	<input checked="" type="checkbox"/>	<input checked="" type="checkbox"/>

Deployment Info	# of Nodes	Comm Radius	# of sinks	Avg # of Ngb
500	500	60	1	14.80...

Simulation Results

- If you did not click on Show Events, or did not select the option to save the events in a log file, there is no way to get them back
- Click on Live Stats to observe the events during the execution of the experiment
 - The stats window show the statistics of the simulation
 - This option is not recommended to be active for long periods of time because it can generate an overflow of the Java VM cache memory, causing the program to break down, without any possibility of recovering any results!

Simulation Results

- Individual node information
 - Get the mouse and click on any of the nodes on the deployment
 - You will see that the node grows and turns into an yellow color
 - Go to the tear Node Stats
 - If you want to see any other node by the ID, write the ID on the text box and click on the Generate Stats button

Simulation Results

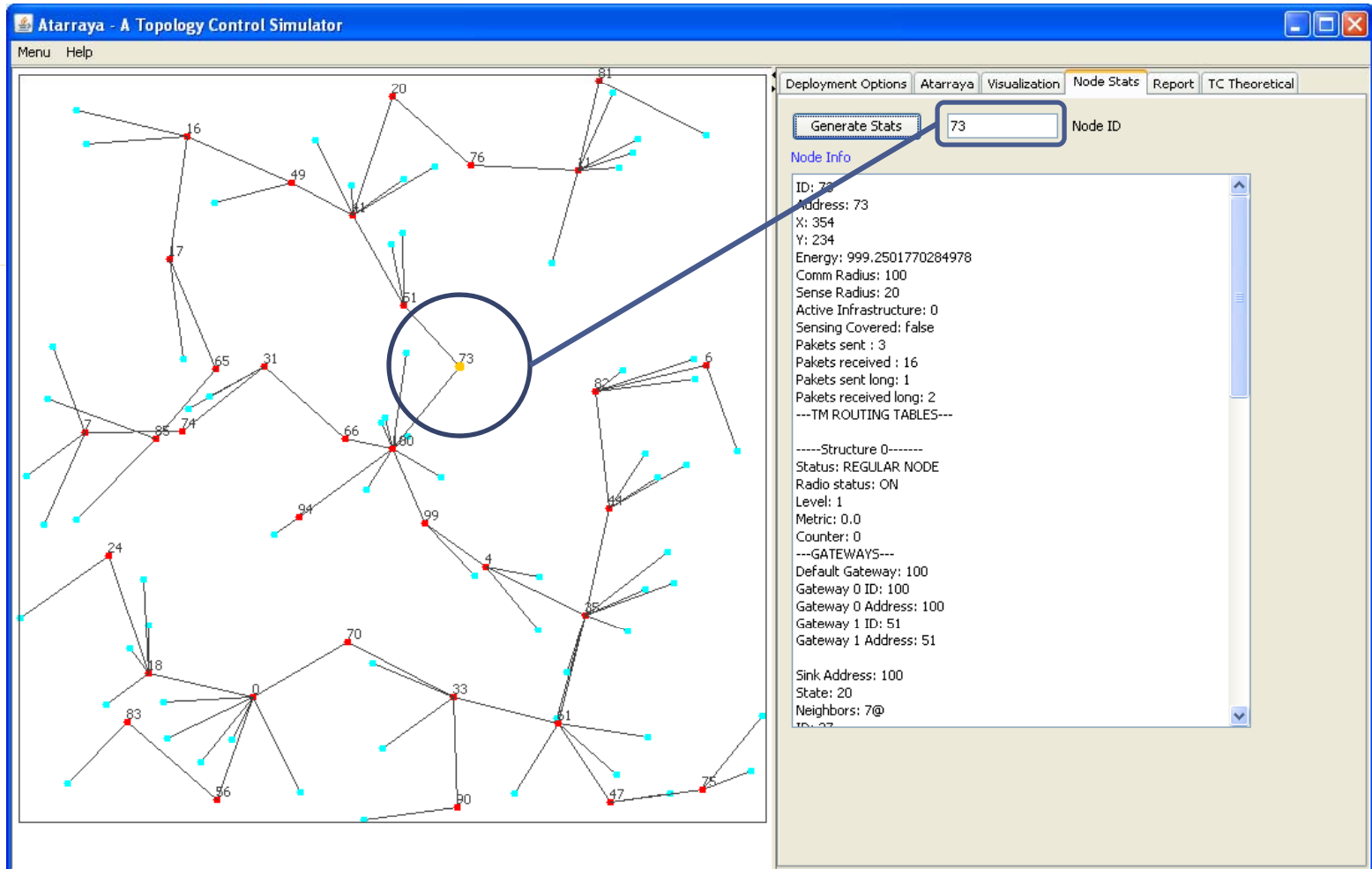

Experiment II-b

Default Topology, Topology Construction, No Maintenance

- Area: 600 x 600mts
- Nodes
 - 100 nodes, distributed uniformly in the area, 1000 mJ of energy constant
 - A single sink node in the center of the area
 - Communication radius = 100mts
 - Sensing radius = 20mts
- Protocols
 - Topology Construction: A3
 - Metric: $W1=0.5$, $W2=0.5$, Linear combination of the metrics
 - Topology Maintenance: Non Isolated Sink (No topology maintenance)
- Results
 - Performance stats
 - Lifetime evaluation

Experiment II-b

- The Deployment Options tab has a second section for the defining of other special parameters
- Metric weights and usage
 - Defined for topology construction protocols
- Inter-query period
 - Defined for sensor & data protocols. Determines how often the sensor is reading the sensor
- Inter-rest period
 - Defined for time-based topology maintenance protocols. Determines how often the maintenance procedure is invoked
- Energy threshold step
 - Defined for energy-based topology maintenance protocols. Determines how much the energy changes between invocation to the topology maintenance protocol

Experiment II-b

- Some topology control protocols use metrics on their operation
 - Distance, energy, probability, etc.
- Atarraya allows a node to have 2 metrics, M1 and M2, which can be used individually or jointly, this last option can be used in three ways
 - Linear combination $W1M1 + W2M2$
 - Clustering values based on M1, and internally sorting by M2. The clustering is done in slots with size defined by the parameter Candidate Grouping Step
 - Clustering values based on M2, and internally sorting by M1

Deployment Generation

Dual Metric Sorting Method Selection, and Size of bins for primary metric sorting

Definition of weights for metrics based on linear combination

Sensor-Data protocol variables

Topology Maintenance protocol variables

The screenshot shows a software interface with a blue header bar. Below the header, there are tabs: "Deployment Options", "Atarraya", "Visualization", "Node Stats", and "Report". The "Deployment" tab is selected, and within it, the "Other Params." sub-tab is active. The "Other Parameters" section contains three main areas:

- Metric Definition:** Includes a "Sorting mode" dropdown menu set to "Metric1 only", a "Candidate Grouping Step" input field with the value "0.25", and a "Weights" section with input fields for "W1" (0.5), "W2" (0.5), and "Step" (0.20). There is a checkbox for "Create all steps" and a "Set Weights Now" button.
- S-D protocol Interquery time:** Includes an "Interquery time" input field with the value "10" and a "Set InterQ Time Now" button.
- TM Protocols Variables:** Includes an "Inter-Reset Period" input field with the value "1000" and an "Energy Threshold Step" input field with the value "0.9".

Deployment Generation

Definition of the metric parameter

Metric weights of $W1=0.5$ and $W2=0.5$, and the linear combination of them

When the option Linear combination is selected, only W1 and W2 must be defined. The rest of the parameters can be left with their default value

Assuming that the values from the Deployment tab are the default ones, this extra parameters must be defined before creating the topology. Once they have been defined, click on the **Create deployment button** to create the topology

The screenshot shows a software window titled 'Deployment Generation' with a blue header bar. Below the header are several tabs: 'Deployment Options', 'Atarraya', 'Visualization', 'Node Stats', 'Report', and 'TC Theoretical'. The 'Other Params.' tab is selected. Inside this tab, there are several sections:

- Metric Definition:** A dropdown menu is set to 'Linear Combination (W1*Metric1+W2*M...'. Below it, 'Candidate Grouping Step' is set to 0.25.
- Weights:** 'W1' is set to 0.5 and 'W2' is set to 0.5. There is a checkbox for 'Create all steps' which is unchecked.
- Step:** Set to 0.20, with a 'Set Weights Now' button.
- S-D protocol Interquery time:** Set to 15, with a 'Set InterQ Time Now' button.
- TM Protocols Variables:** 'Inter-Reset Period' is set to 1200 and 'Energy Threshold Step' is set to 0.9.

At the bottom of the window, there is a 'Create Deployment' button, which is highlighted with a red box. To its right are two checked checkboxes: 'Generate Deployment?' and 'Check Connectivity Exhaustively'.

Protocol Selection

Definition of the protocols

A3, Non Isolated sink, Simple S&D, Simple Forwarding

Parameters for Statistics

Stats, and Lifetime evaluation

•Again, click on the **Start Atarraya** button. DO NOT USE THE RUN BUTTON FOR THIS EXPERIMENT!

The screenshot shows the Atarraya software interface with the following components:

- Deployment Options:** Atarraya, Visualization, Node Stats, Report, TC Theoretical
- Select Protocol:**
 - TC protocol: A3
 - Sensor & Data protocol: Simple S&D protocol
 - TM Protocol: Non Isolated Sink
 - Routing / Forwarding Protocol: Simple Forwarding
- All sinks at once? (if multiple infrastructure selected)
- Actions / Events:**
 - Start Atarraya!! (highlighted with a red box)
 - Stop Agent
 - Pause Agent
- Queue Size:** [input field]
- Events:** [input field]
- Stats:** Max Sim Time: 100000
- Live stats
- Covered Area too?
- Stats Report:**
 - Save Stats
 - All? Step: 20
 - Excel ready format (CSV)
 - Individual Report
 - Summarized Report
 - Save events log (indiv only)
 - Save Lifetime log (Summ. Only)
 - File path: _tutorial_default_ Description
- Batch Simulation:**
 - Select Files: 0 files selected
 - Run! [input field] X Replicates
- Progress:** [input field]

Simulation Results

Summarized lifetime results figure

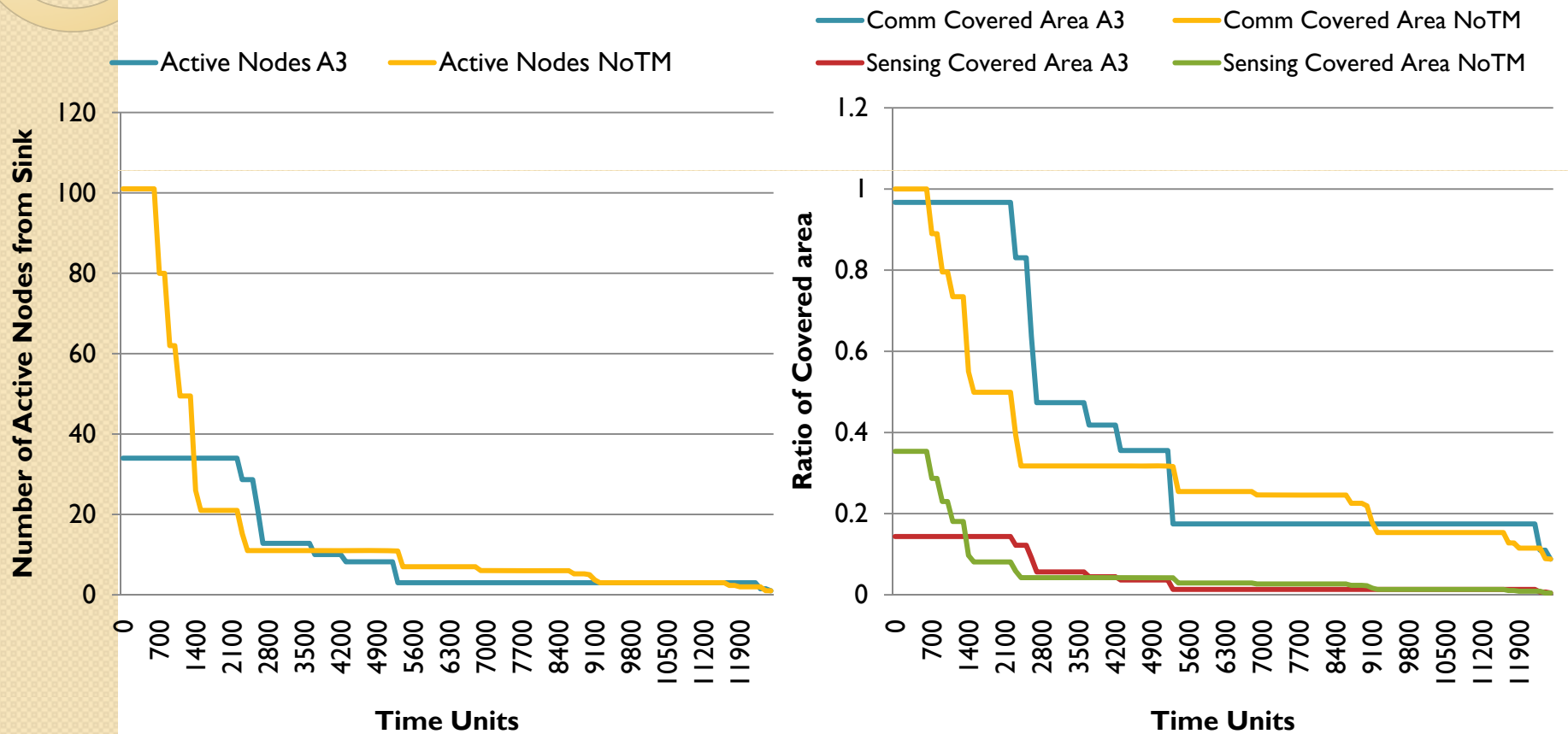

Coverage-oriented Topology Construction





Coverage-oriented Topology Construction

- The main objective of a WSN is to monitor events, thus coverage is necessary to have to ability to detect the events
- There are different types of coverage:
 - **Target coverage**
 - Coverage of certain elements of high interest need to be monitored
 - **Area coverage**
 - Provide total or partial coverage of the area of interest
 - **Border coverage**
 - Coverage over an specific border (intrusion detection) or to evaluate coverage

Coverage Models

- Boolean coverage
 - Sectors
 - Disk

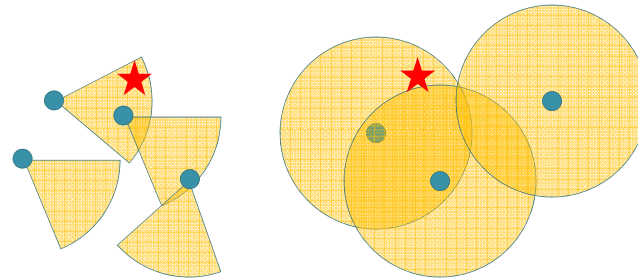

- Attenuated coverage
 - Attenuated disk coverage
 - Truncates attenuated disk coverage

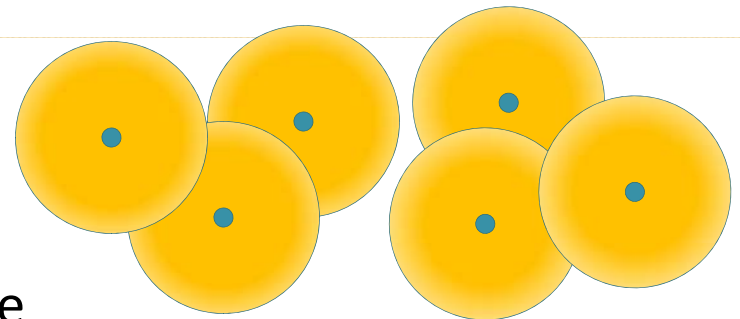

- Detection and Estimation coverage models
 - Nodes cooperate to the detection or estimation of events
 - Useful approach in areas distant from all adjacent nodes, but covered by more than 1, event with low probability

Target Coverage

- Protocols in this category must cover a set of discrete points distributed in the area of interest
 - One approximation is to use the **Set Cover problem**, when the network topology is already given
 - Find the **optimal deployment** to cover all the points with the minimum number of nodes
 - Usually available sites for the covering nodes are predetermined
 - Small number of sites → Optimal global solution is possible
 - More sites → higher complexity for optimal global solution
 - Use of approximation is common: Genetic algorithms, Greedy Set Cover, Simulated Annealing, etc.

Target Coverage

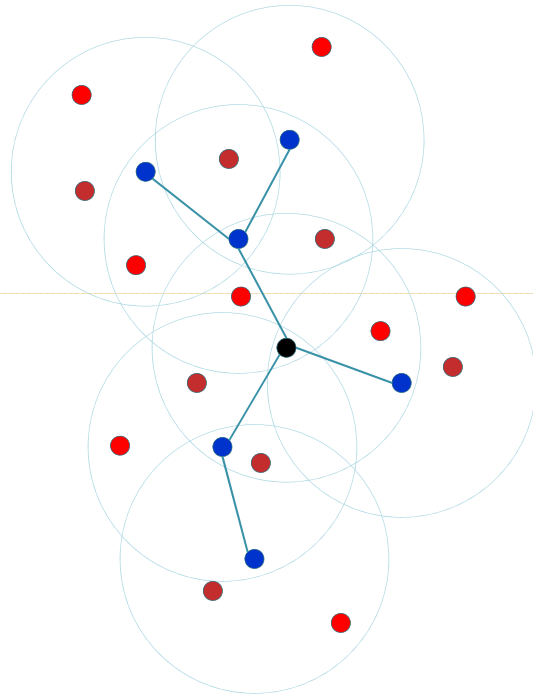

Connected Dominating Set
(Example of **Set Cover-based** approach)

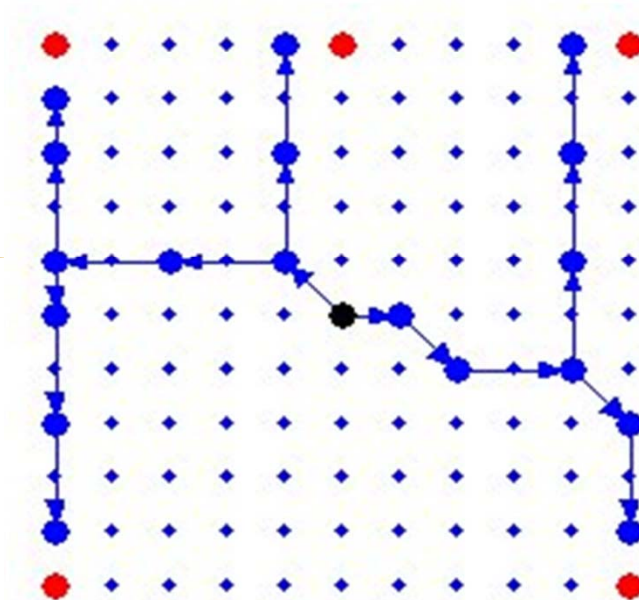

Grid-based selection of
optimal connected deployment

Area Coverage

- The first step to provide area coverage is to determine how many nodes are needed: Critical Sensor Density (CSD)

- There are two main ways to do this:
 - Deterministic placement
 - When the administrator can place the nodes by-hand in exact locations
 - Based on geometric properties: grids, tessellation, lattices, etc.
 - Random placement
 - When the network is deployed randomly over the area of interest
 - Probability-based densities, based on vacancy analysis

Optimal Deployments

- Square grid
 - Horizontal and vertical grid lines

$$D/r$$

$$n = \frac{D^2}{r^2}$$

$$\frac{n}{D^2} = \frac{1}{r^2}$$

$$D \rightarrow \infty, d_{SQR} = \frac{1}{r^2}$$

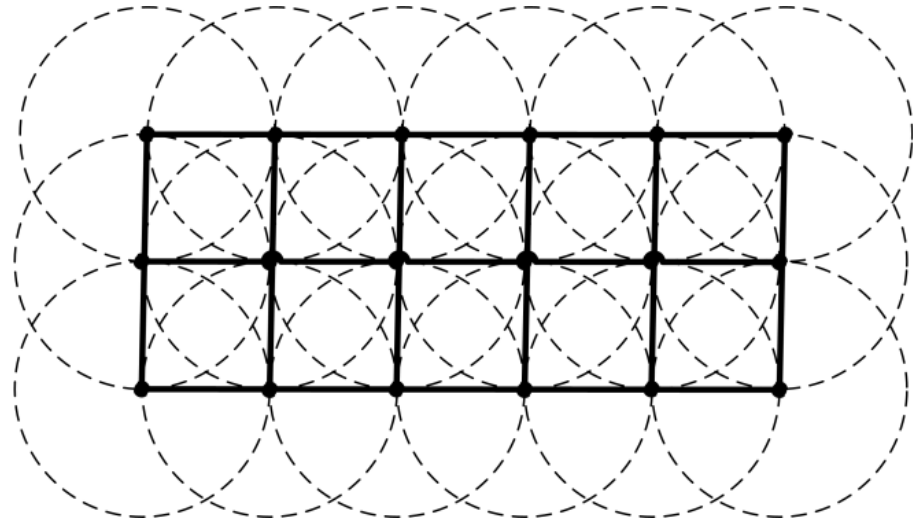

Optimal Deployments

- Strip-based deployment

- Distance between

vertical strips $\left(\frac{\sqrt{3}}{2} + 1\right)r$

$$n = \frac{D}{\left(\frac{\sqrt{3}}{2} + 1\right)r} \cdot \frac{D}{r}$$

- Distance between

nodes in the strip is r

$$= \frac{1}{\left(\frac{\sqrt{3}}{2} + 1\right)} \cdot \frac{D^2}{r^2}$$

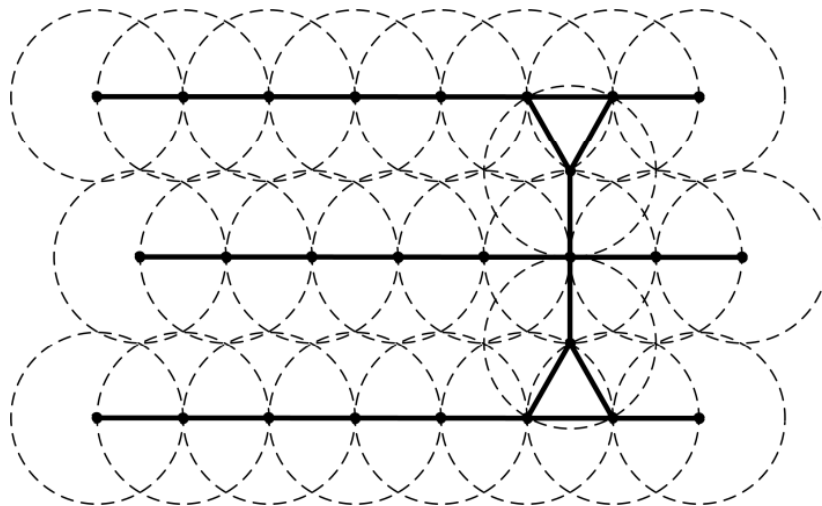

$$\approx 0.536 \frac{D^2}{r^2}$$

Optimal Deployments

- If communication and sensing ranges are different, the previously defined density functions are not optimal, like in the case of the Triangle Lattice deployment

$$\begin{aligned}
 r_{comm} &= r_{sense} \sqrt{3} \\
 d_{LAT} &= \frac{2}{r_{sense}^2 3\sqrt{3}} \\
 &= \frac{0.3849}{r_{sense}^2} < \frac{0.536}{r^2}
 \end{aligned}$$

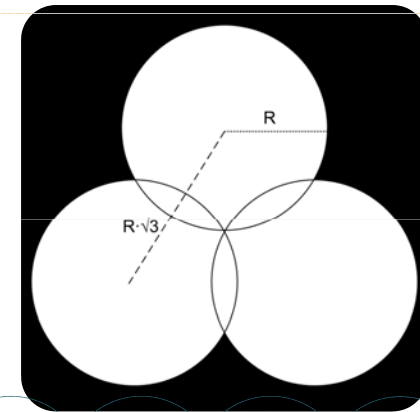

Nodes for connecting series of lattices

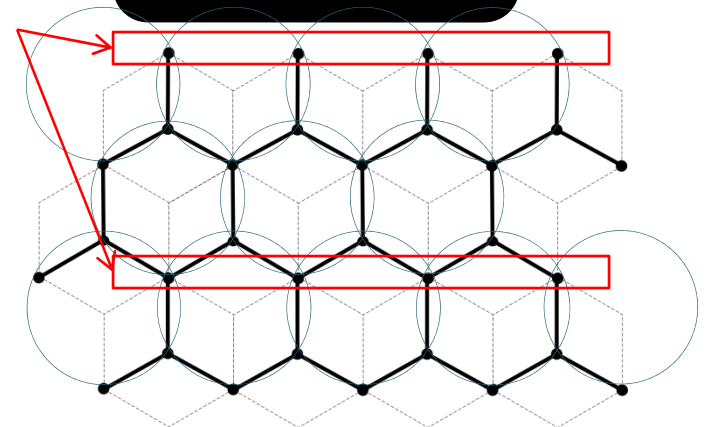

Optimal Deployments

$$R_{\text{comm}} = \sqrt{3} R_{\text{sense}} \text{ [Bai2008]}$$

- Formulas that apply when communication and sensing radii are not the same

$$d_{SQR} = R_{\text{Sense}}^2 \left(\min \left\{ \sqrt{2}, \frac{R_{\text{Comm}}}{R_{\text{Sense}}} \right\} \right)^2$$

$$d_{RHO} = R_{\text{Comm}}^2 \sin(\Theta)$$

$$\frac{\pi}{3} \leq \Theta \leq \frac{\pi}{2} \quad \text{and} \quad \sqrt{2} \leq \frac{R_{\text{Comm}}}{R_{\text{Sense}}} \leq \sqrt{3}$$

$$d_{HEX} = \frac{3}{4} \sqrt{3} R_{\text{Sense}}^2 \left(\min \left\{ 1, \frac{R_{\text{Comm}}}{R_{\text{Sense}}} \right\} \right)^2$$

$$d_{STR} = 1/\beta \sqrt{R_{\text{Sense}}^2 + \beta^2/4}$$

$$\beta = \min \left\{ R_{\text{Comm}}, \sqrt{3} R_{\text{Sense}} \right\}$$

Comparison of optimal deployments when $R_{\text{comm}} = R_{\text{sense}}$

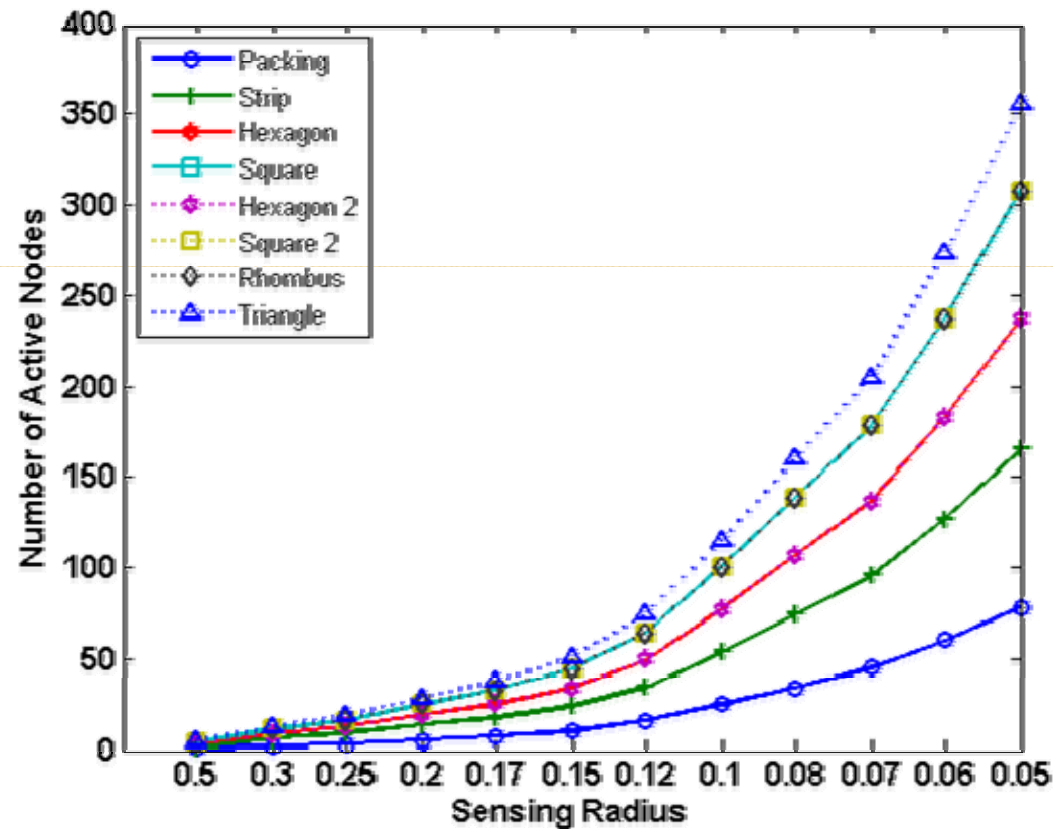

The first four functions are from [Iyengar2005]; the second set are from [Bai2008]. It can be seen how the optimal deployment is the Strip from [Iyengar2005], while all the others show more or less the same behavior: Hex = Hex2, Square2 = Strip2(not shown) = Rhombus2 = Square

Vacancy Analysis For Random Placement

Crossing point

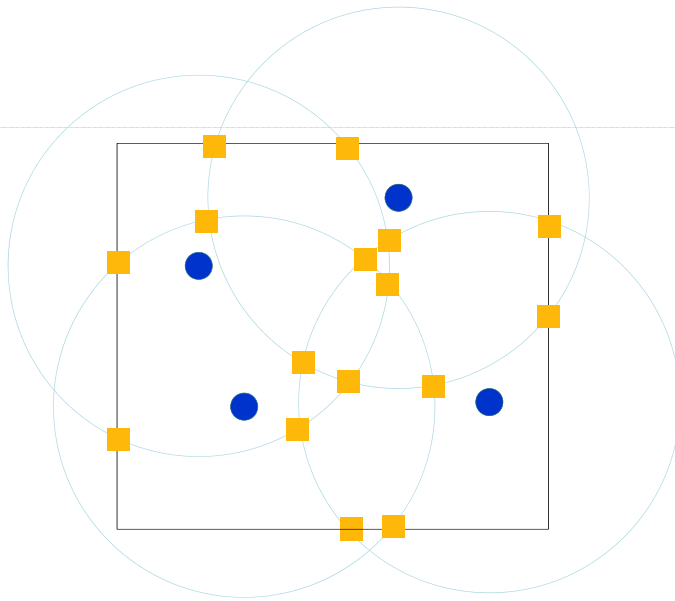

Grid points

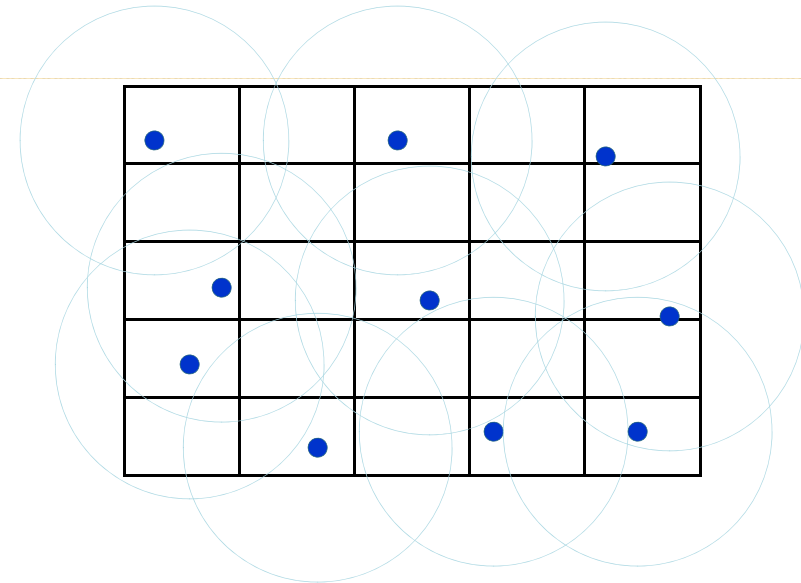

Random Placement

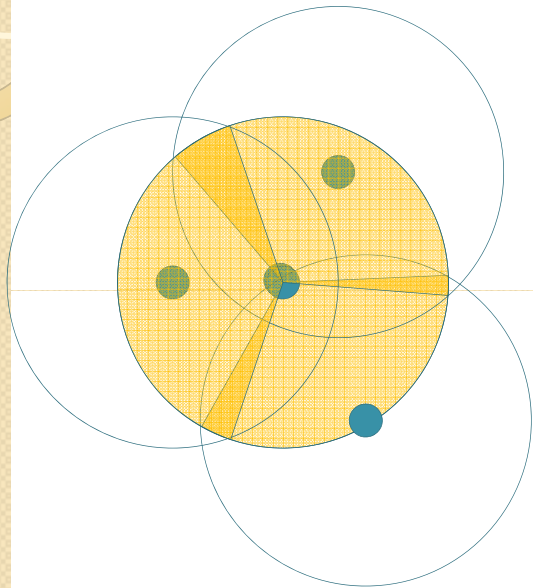

Sponsored Sector

Crossing Covering

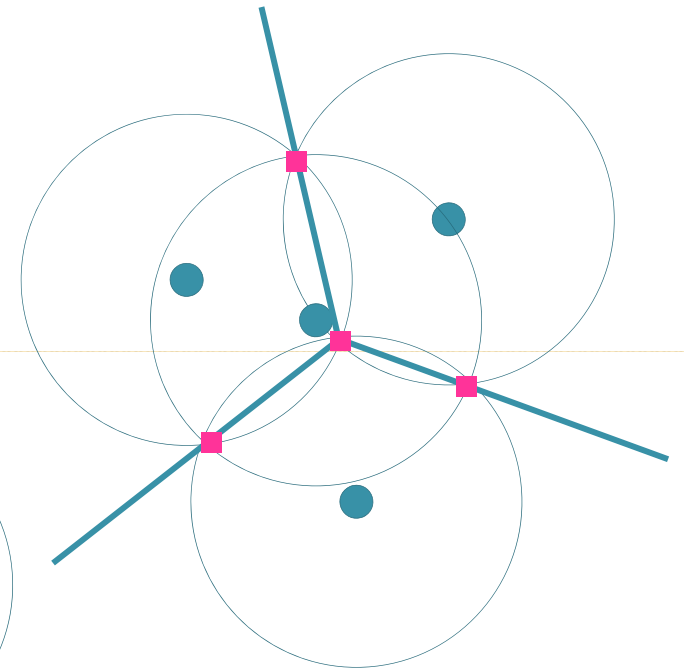
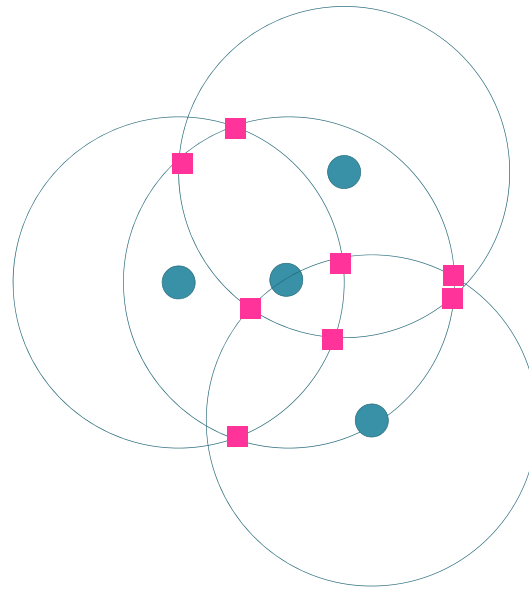

Voronoi

Border Coverage

- A set of sensors that cover a belt against crossing paths
 - Belt is the area between two parallel curves
 - Crossing path is a way through the belt that does not touch any sensing range

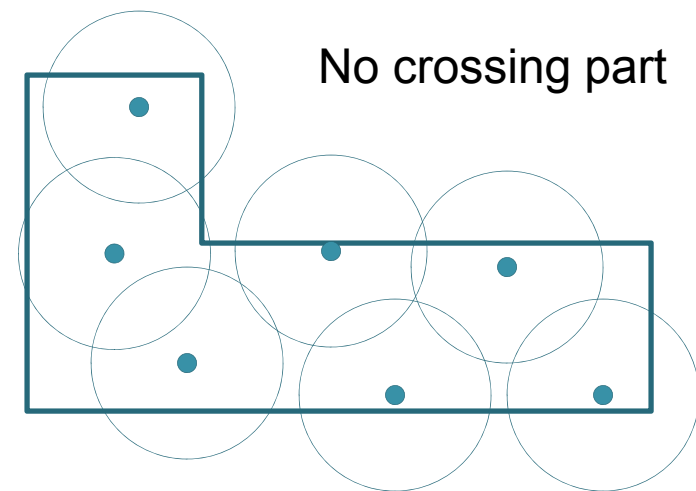
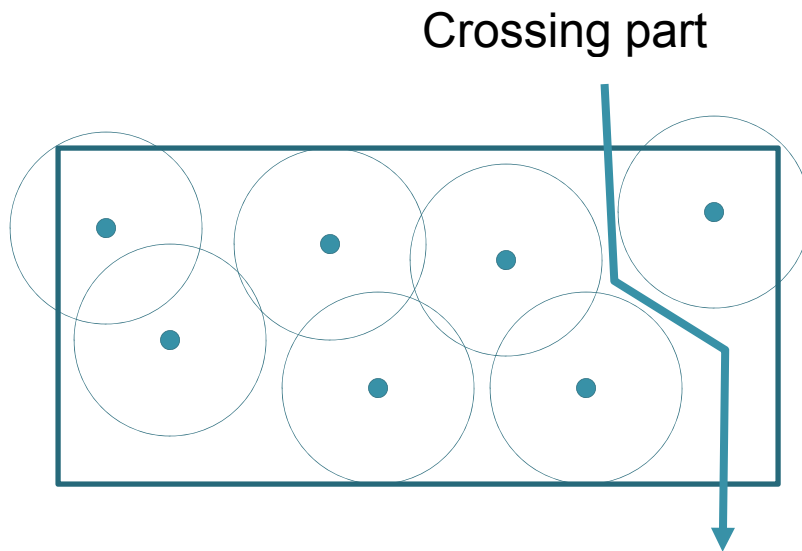



**EXPERIMENTS
PART III –
TOPOLOGY
CONSTRUCTION WITH
COVERAGE**

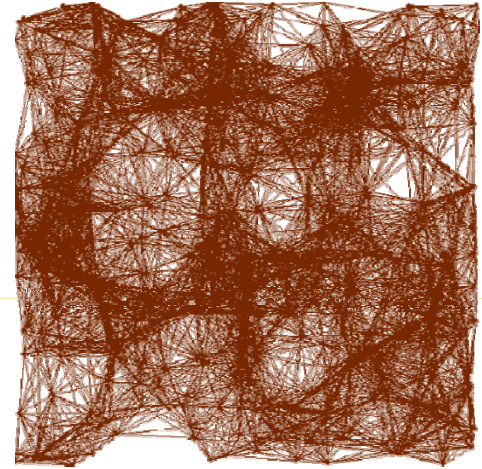

Experiment III-a

Default Topology, Topology Construction with Coverage, No Maintenance

- Area: 600 x 600mts
- Nodes
 - 100 nodes, distributed uniformly in the area, 1000 mJ of energy constant
 - A single sink node in the center of the area
 - Communication radius = 100mts
 - Sensing radius = 20mts
- Protocols
 - Topology Construction: A3Cov
 - Metric: $W1=0.5$, $W2=0.5$, Linear combination of the metrics
 - Topology Maintenance: Non Isolated Sink (No topology maintenance)
- Results
 - Performance stats
 - Lifetime evaluation

Protocol Selection

Definition of the protocols

A3Cov, Non Isolated sink, Simple S&D, Simple Forwarding

Parameters for Statistics

Stats, and Lifetime evaluation

•Again, click on the **Start Atarraya** button. DO NOT USE THE RUN BUTTON FOR THIS EXPERIMENT!

The screenshot shows the Atarraya software interface with the following components:

- Deployment Options:** Atarraya, Visualization, Node Stats, Report, TC Theoretical
- Select Protocol:**
 - TC protocol: A3 Coverage
 - Sensor & Data protocol: Simple S&D protocol
 - TM Protocol: Non Isolated Sink
 - Routing / Forwarding Protocol: Simple Forwarding
 - All sinks at once? (if multiple infrastructure selected)
- Actions / Events:**
 - Start Atarraya!!** (highlighted with a red box)
 - Stop Agent
 - Pause Agent
- Queue Size:** [Empty field]
- Events:** [Empty field]
- Stats:** Max Sim Time: 100000
- Batch Simulation:**
 - Select Files: 0 files selected
 - Run! [1] X Replicates
 - Progress: [Empty field]
- Stats Report:**
 - Live stats
 - Covered Area too?
 - Save Stats: All? [20] Step
 - Excel ready format (CSV)
 - Individual Report
 - Summarized Report
 - Save events log (indiv only)
 - Save Lifetime log (Summ. Only)
 - eba_tutorial_a3cov Description

Simulation Results

Summarized lifetime results figure

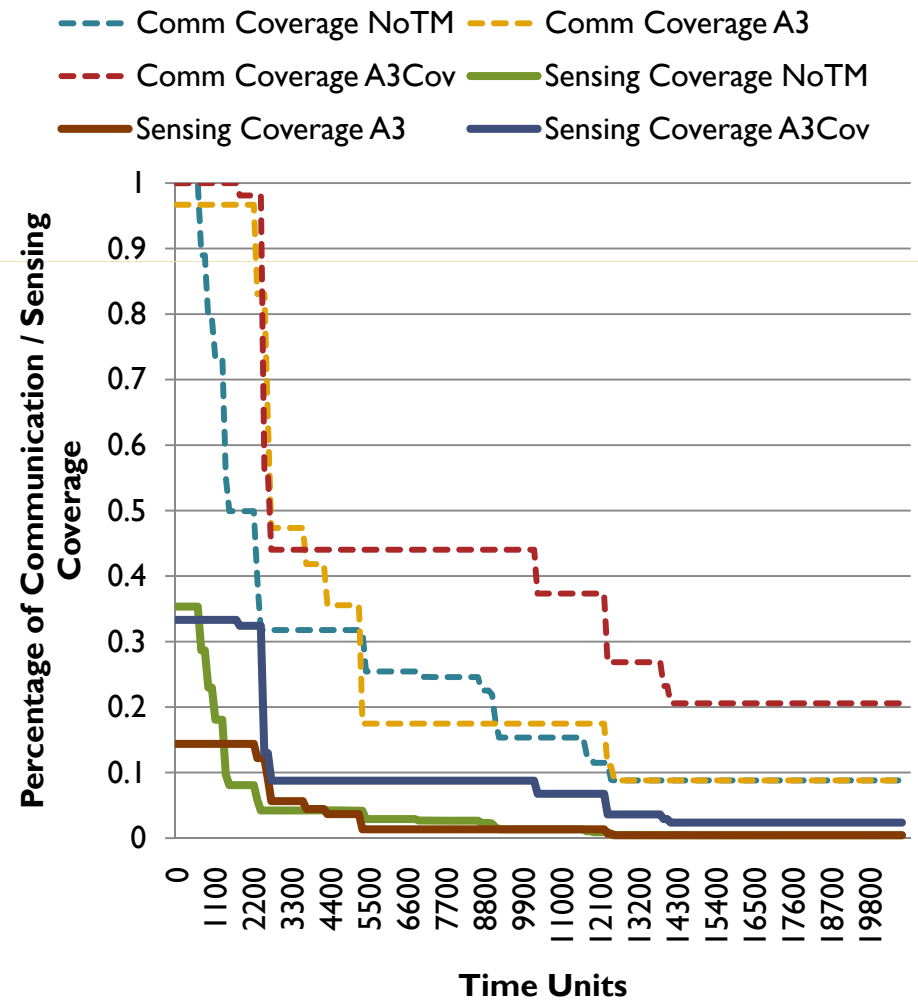
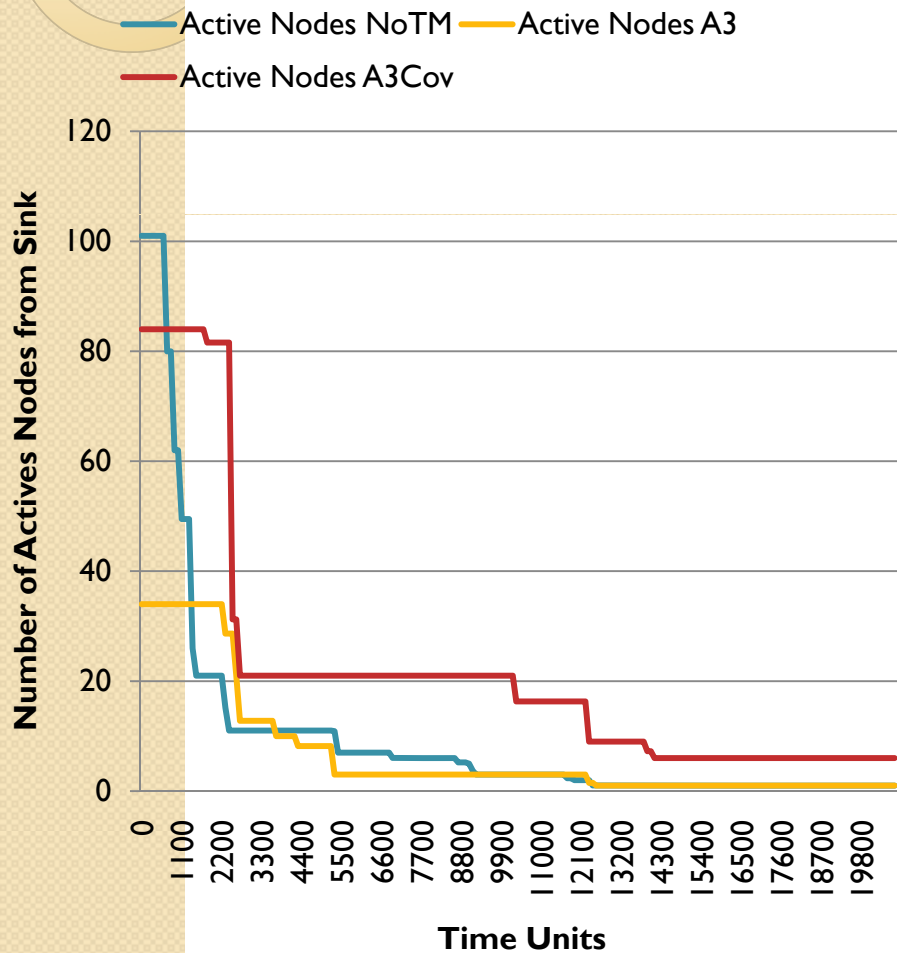



Topology Maintenance





Classification of TM protocols

- The new taxonomy proposes three dimensions of classification:
 - When are the reduced topologies built?
 - Scope of the network
 - Triggering criteria



When Are The Reduced Topologies Built?

Three types have been defined for this dimension:

- **Static**
 - During the topology construction stage, a number of predefined different reduced topologies is created
 - The different reduced topologies will be used during the lifetime of the network, rotating according to the triggering criteria like a Christmas Tree
 - The configuration of the reduced topologies do not change during the life of the network
 - Low overhead – messages just for rotation, not recreation
 - Network usage may degrade the lifetime of the network if many nodes are shared among reduced topologies



When Are The Reduced Topologies Built?

Three types has been defined for this dimension:

- **Dynamic**
 - The algorithms on this class calculate a new topology “on the fly” when invoked by the triggering criteria
 - The previous version of the reduced topology is abandoned and changed by the new one
 - The network will be using all the resources available at the moment to reach the best level of service possible
 - High overhead – each invocation will start a protocol that may be costly in message complexity



When Are The Reduced Topologies Built?

Three types has been defined for this dimension:

- Hybrid

- This is a mixture of Static and Dynamic approaches
- The network works with a number of predefined reduced topologies that rotate during the lifetime of the network, just like in the Static
- When a reduced topology determines that it is not working effectively, it will invoke a Dynamic technique to update and rebuild the reduced topology with the current resources
- Allows update of the predefined static topologies and reduced the overhead of the dynamic approach
- The triggering criteria has a big responsibility on determining when the network is not working properly



Scope of the Network

Two types has been defined for this dimension:

- **Global**
 - All the nodes in the network are involved in the maintenance process
 - More information is available to make a better decision, but may generate overhead
- **Local**
 - Just a subset of the nodes are involved in the maintenance process
 - Will generate a fast solution, but may lead to non-optimal solutions

Triggering Criteria

Six types has been defined for this dimension:

- Time

- The maintenance technique is called periodically
- It distributes the energy consumption, but can generate overhead if called when no needed

- Energy depletion

- The maintenance technique is called whenever a node detects that it has reached a critical level on its energy reserve
- It is run just when needed, but when many nodes are dying, it will be called many times, generating overhead

Triggering Criteria

Six types has been defined for this dimension:

- Failure

- The maintenance technique is called whenever a failure is detected on the network
- May present the same disadvantage of the energy depletion trigger

- Random

- The maintenance technique is called based on a random function
- May not be effective in reacting to failures on the network

Triggering Criteria

Six types has been defined for this dimension:

- **Density**
 - The maintenance technique is called when the node density in an area is not as desired: too low or too high
 - The threshold must be defined very carefully to avoid excessive invocations
- **Combinations**
 - Combinations of triggering criteria may result in a better performance

Topology Maintenance Protocols

- Dynamic Global Time Topology Recreation (DGTTRec) and Dynamic Global Energy Topology Recreation (DGETRec)
 - Wake up all the nodes on the topology
 - Nullify the previous reduced topology
 - Recall the topology construction protocol to build a new one
- Static Global Time Topology Rotation (SGTTRot) and Static Global Energy Topology Rotation SGETRot
 - Wake up all the nodes on the topology
 - Notifies the next predefined reduced topology that will take charge
 - The nodes change their status accordingly to their status on the upcoming predefined topology (active or sleep)

Topology Maintenance Protocols

- Hybrid Global Time Topology Recreation Rotation (HGTTRecRot) and Hybrid Global Energy Topology Recreation Rotation (HGETRecRot):
 - Wake up all the nodes on the topology
 - Rotate the predefined topologies, until one of the them is not considered active anymore
 - A topology is assumed to be dead when the sink node has no active neighbors
 - At this point the protocol will call the topology construction protocol to rebuild that particular reduced topology

Topology Maintenance Protocols

- Dynamic Local Energy-DSR-based (DLE-DSR):
 - Node A will invoke the protocol when its energy is almost depleted
 - Wake up all 2- to 3-hops away nodes from node A
 - Use a modified DSR protocol to find paths from the “grandpa” node (father of node A) to the “children” nodes (all nodes depending on A)
 - Find the best paths according to:
 - Energy of the nodes in the path
 - Total length of the path
 - Number of hops
 - Activate all nodes selected to be part of a path
 - Return all the nodes to their previous state (active remain active, sleeping nodes go back to sleep)

Topology Maintenance Protocols

● Orphan Node ● Energy Depleted Node ○ TM Ready Node ● Grandpa Node

- Example of the wake up protocol

- Nodes 2-hops away from the node, in higher levels
- Nodes 3-hops away from the node, in lower levels

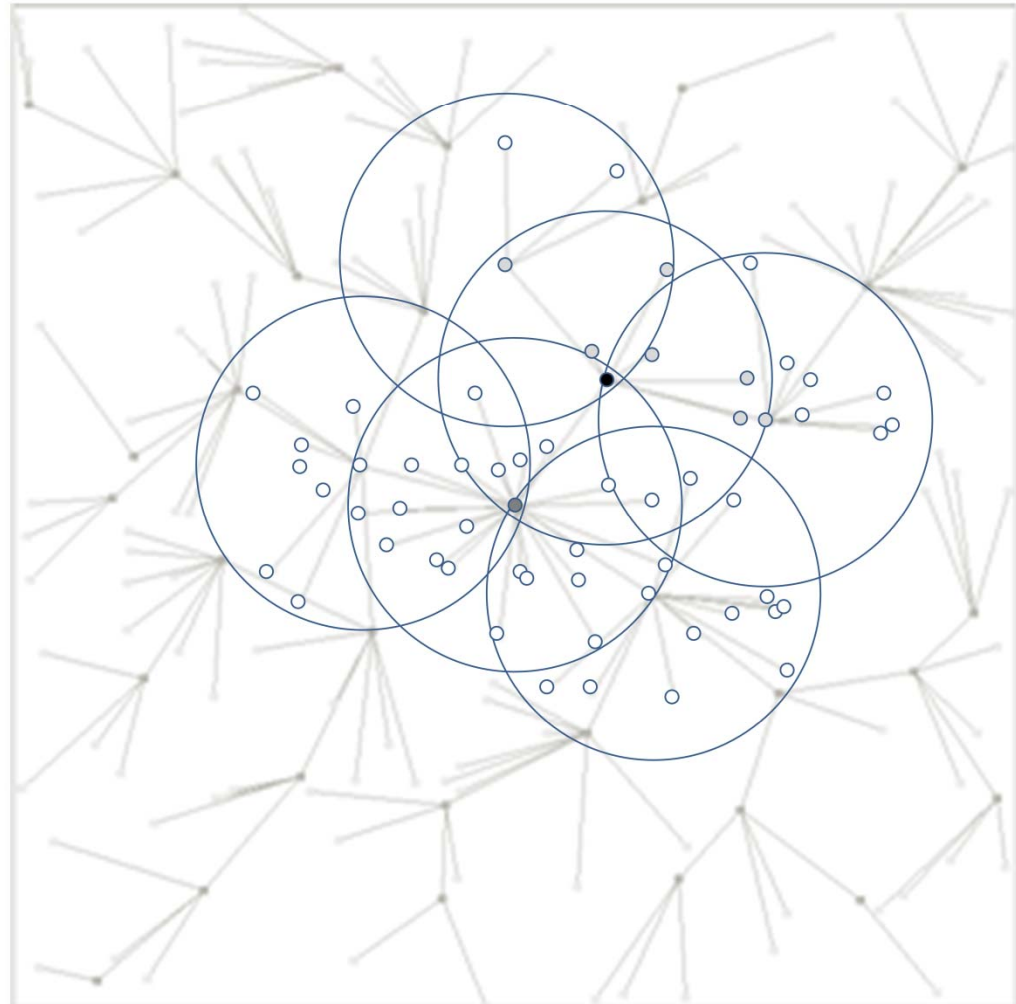

Topology Maintenance Protocols

- Probabilistic Scheduling
 - Asynchronous
 - All the nodes work in rounds, but independently defined
 - Each node define the amount of awake time $p \times T$, where $p \in [0,1]$ is random number and T is the duration of each round
 - Synchronous
 - Non-disjoint
 - Each node will be awake in a certain round with probability p
 - Disjoint
 - Nodes are organized in disjoin sets
 - Each set will be awoken at the beginning of each round, and the rest will be inactive

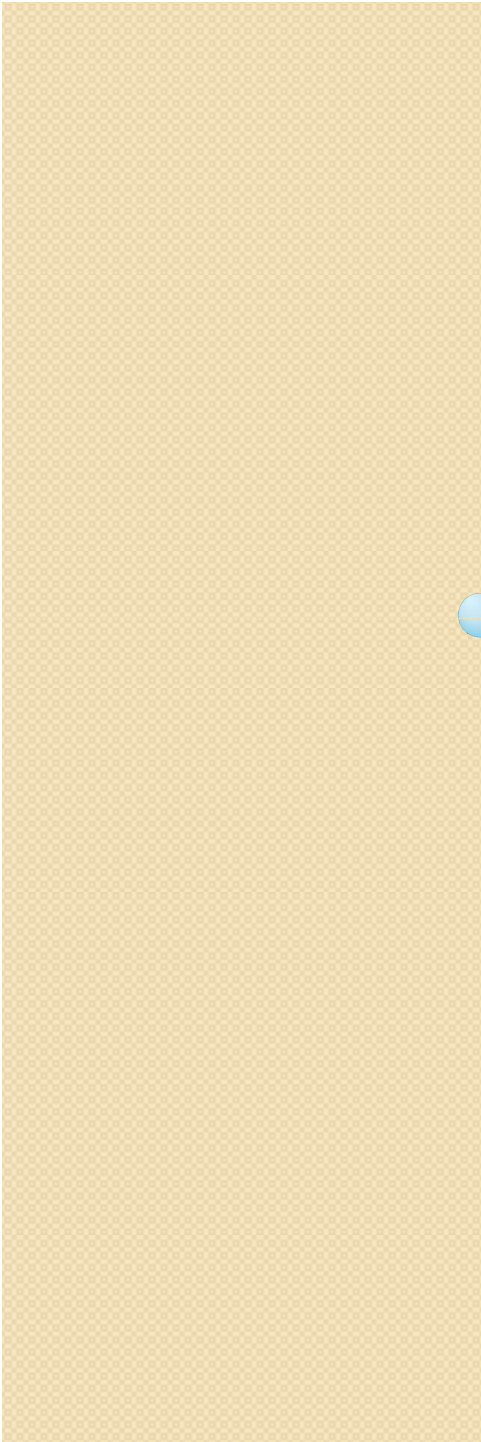

**EXPERIMENTS
PART IV –
TOPOLOGY
MAINTENANCE**

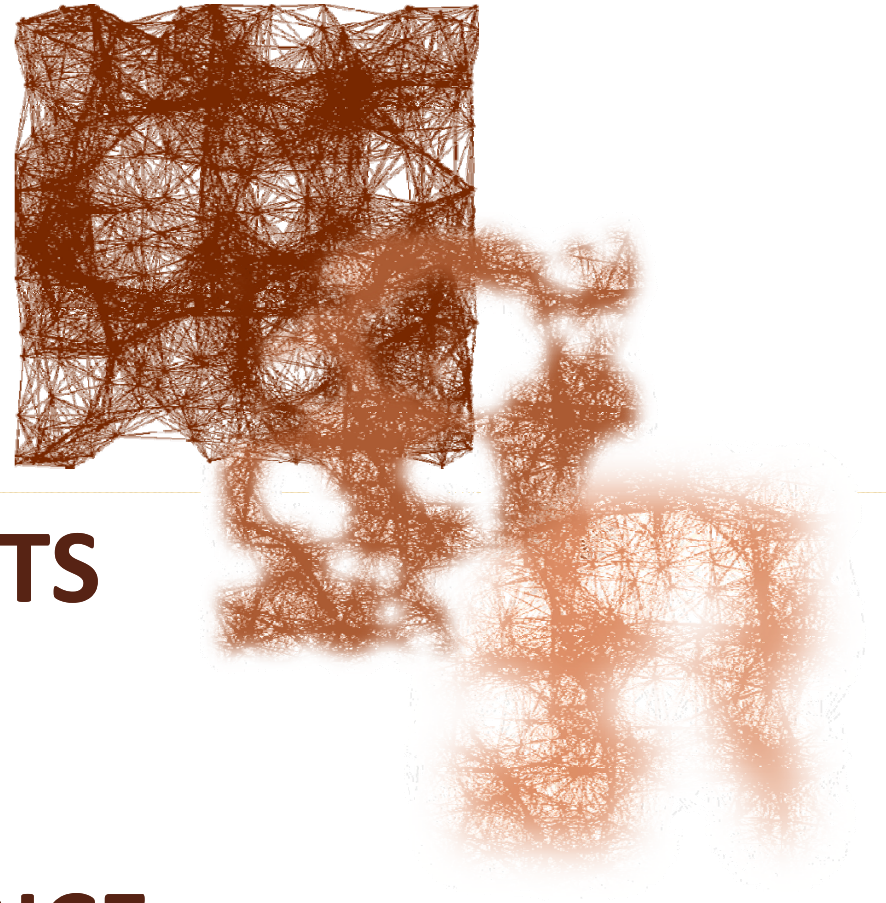

Experiment IV-a

Default Topology, Topology Construction with Coverage, with Topology Maintenance

- Area: 600 x 600mts
- Nodes
 - 100 nodes, distributed uniformly in the area, 1000 mJ of energy constant
 - A single sink node in the center of the area
 - Communication radius = 100mts
 - Sensing radius = 20mts
- Protocols
 - Topology Construction: A3Cov
 - Metric: $W1=0.5$, $W2=0.5$, Linear combination of the metrics
 - Topology Maintenance: DGTTRec
 - Inter-reset period: 1200 time units
- Results
 - Performance stats
 - Lifetime evaluation

Deployment Generation

Definition of the metric parameter

Metric weights of $W1=0.5$ and $W2=0.5$, and the linear combination of them

Inter-reset period of 1200 time units

Define the inter-reset period for the topology maintenance protocol, which defines how often the maintenance will be invoked

Once they have been defined, click on the **Create deployment button** to create the topology

The screenshot shows a software window titled "Deployment Generation" with a blue header bar. Below the header are several tabs: "Deployment Options", "Atarraya", "Visualization", "Node Stats", "Report", and "TC Theoretical". The "Deployment Options" tab is active, and within it, the "Other Params." sub-tab is selected. The "Other Parameters" section contains three main configuration areas:

- Metric Definition:** A dropdown menu is set to "Linear Combination ($W1 * Metric1 + W2 * M...$)". Below it, a "Candidate Grouping Step" is set to 0.25.
- Weights:** Two input fields for "W1" and "W2" are both set to 0.5. There is a checkbox for "Create all steps" which is currently unchecked. A "Step" field is set to 0.20, and a "Set Weights Now" button is present.
- S-D protocol Interquery time:** An "Interquery time" field is set to 15, with a "Set InterQ Time Now" button.
- TM Protocols Variables:** An "Inter-Reset Period" field is set to 1200, and an "Energy Threshold Step" field is set to 0.9.

At the bottom of the window, there is a "Create Deployment" button highlighted with a red box. To its right are two checked checkboxes: "Generate Deployment?" and "Check Connectivity Exhaustively".

Protocol Selection

Definition of the protocols

A3Cov, Non Isolated sink, Simple S&D, Simple Forwarding

Parameters for Statistics

Stats, and Lifetime evaluation

•Again, click on the **Start Atarraya** button. DO NOT USE THE RUN BUTTON FOR THIS EXPERIMENT!

The screenshot shows the Atarraya software interface with the following components:

- Deployment Options:** Atarraya, Visualization, Node Stats, Report, TC Theoretical
- Select Protocol:**
 - TC protocol: A3 Coverage
 - Sensor & Data protocol: Simple S&D protocol
 - TM Protocol: Non Isolated Sink
 - Routing / Forwarding Protocol: Simple Forwarding
 - All sinks at once? (if multiple infrastructure selected)
- Actions / Events:**
 - Start Atarraya!! (highlighted with a red box)
 - Stop Agent
 - Pause Agent
- Queue Size:** [Empty field]
- Events:** [Empty field]
- Stats:** Max Sim Time: 100000
- Batch Simulation:**
 - Select Files: 0 files selected
 - Run! [1] X Replicates
 - Progress: [Empty field]
- Stats Report:**
 - Live stats
 - Covered Area too?
 - Save Stats
 - Excel ready format (CSV)
 - Individual Report
 - Summarized Report
 - Save events log (indiv only)
 - Save Lifetime log (Summ. Only)
 - Step: 20
 - File name: eba_tutorial_a3cov
 - Description: [Empty field]

Simulation Results

Summarized lifetime results figure

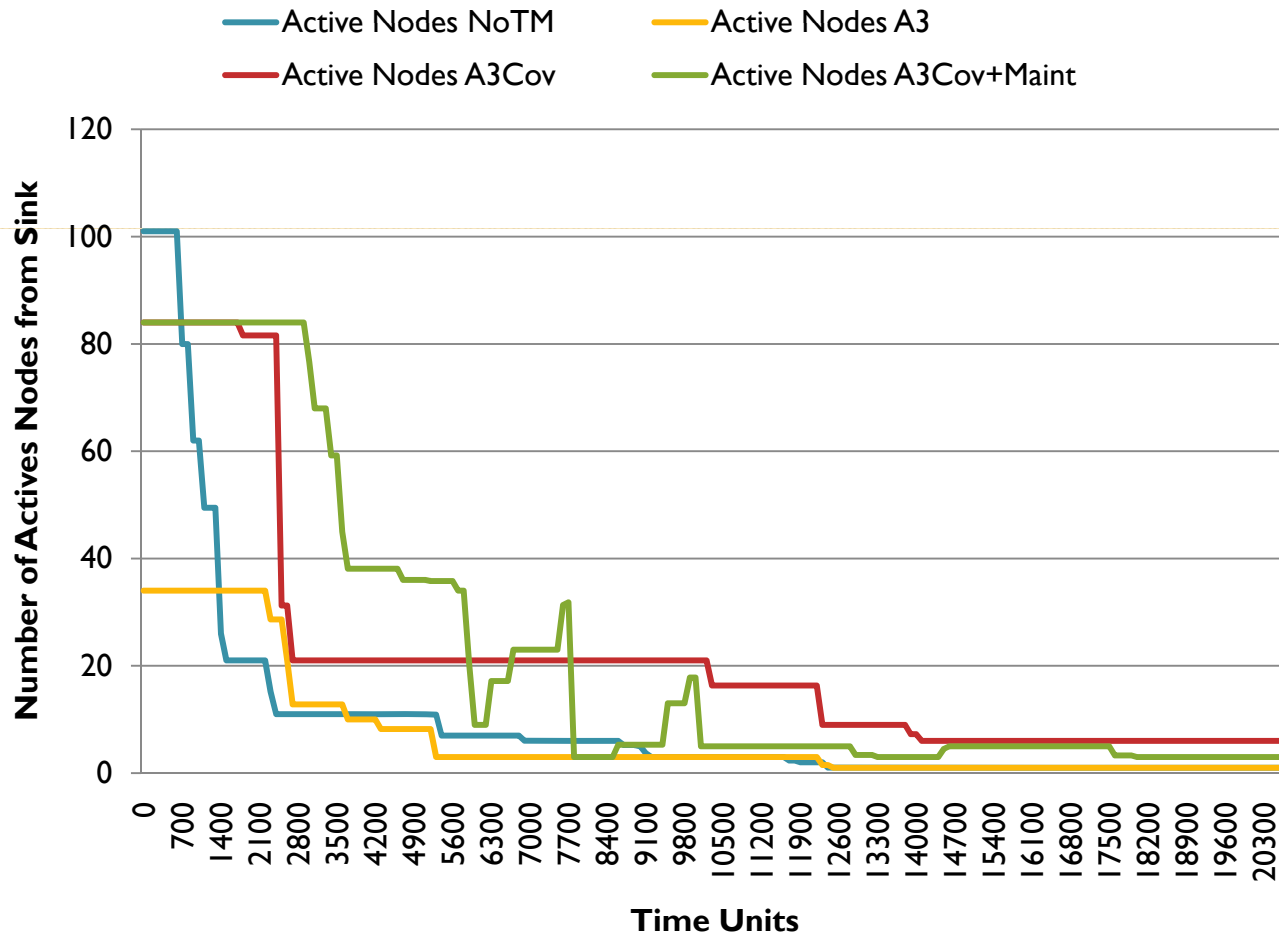

Simulation Results

Summarized lifetime results figure

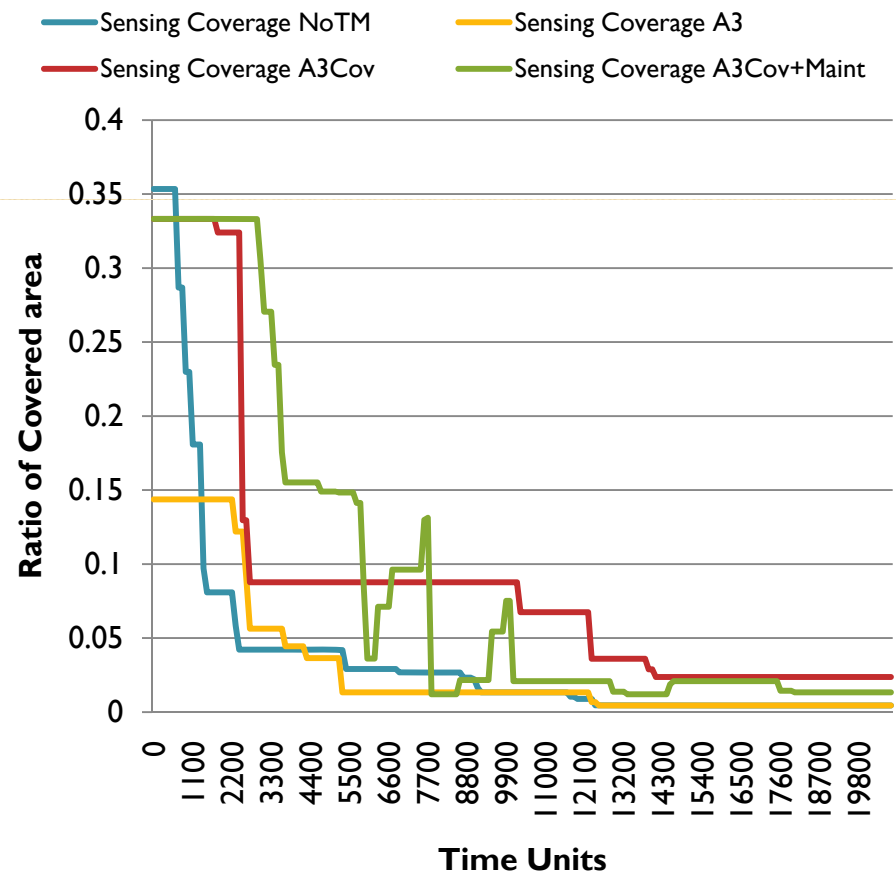
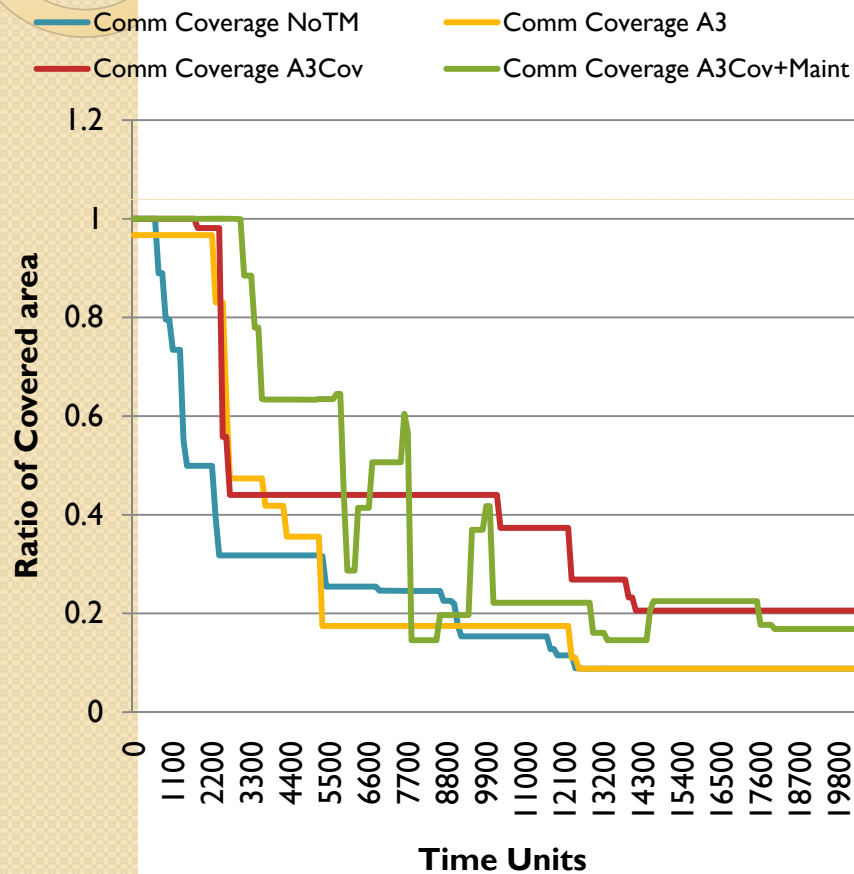

Simulation Results

Lifetime of the Network - Covered Area

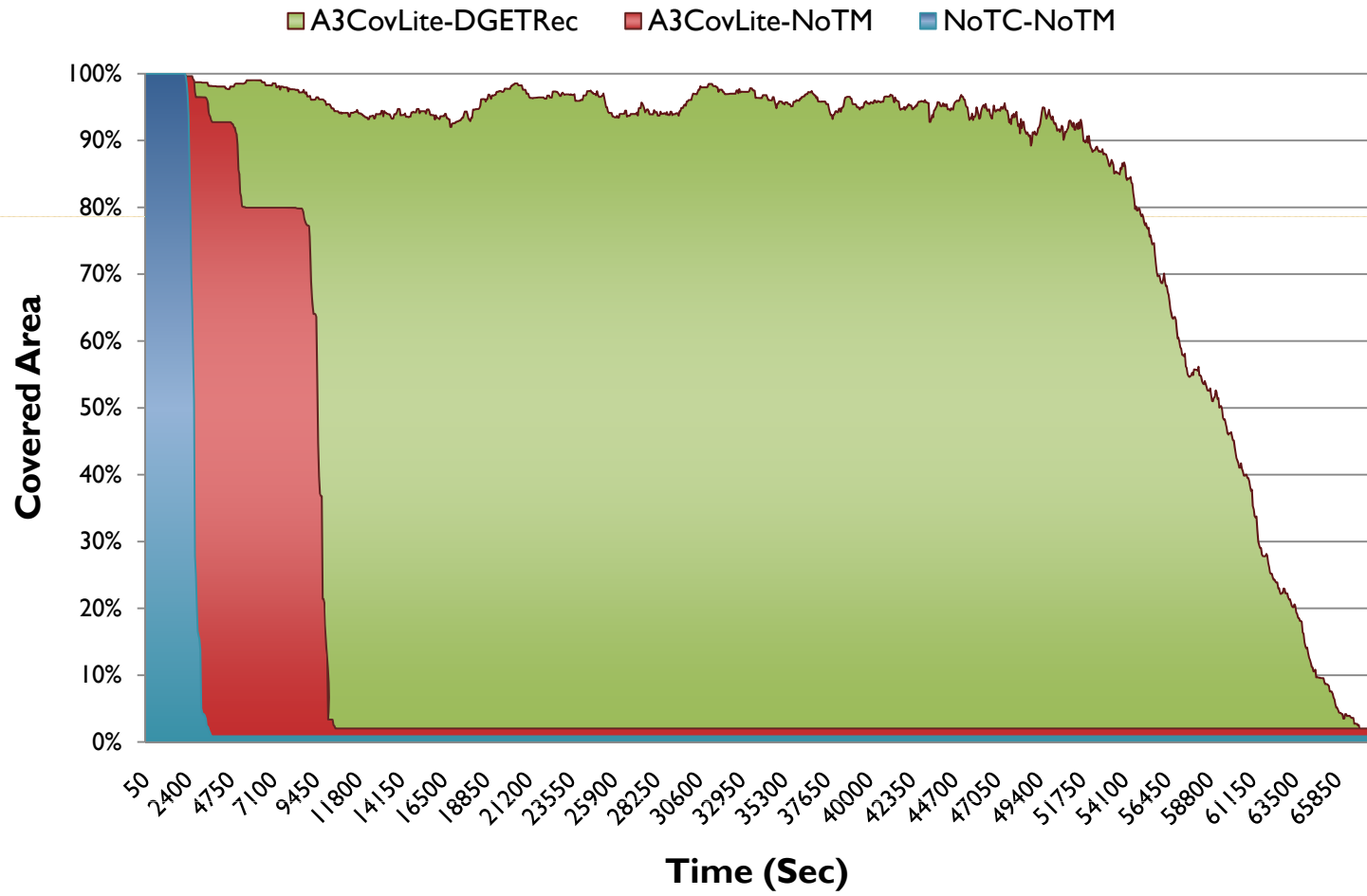



CONCLUSIONS

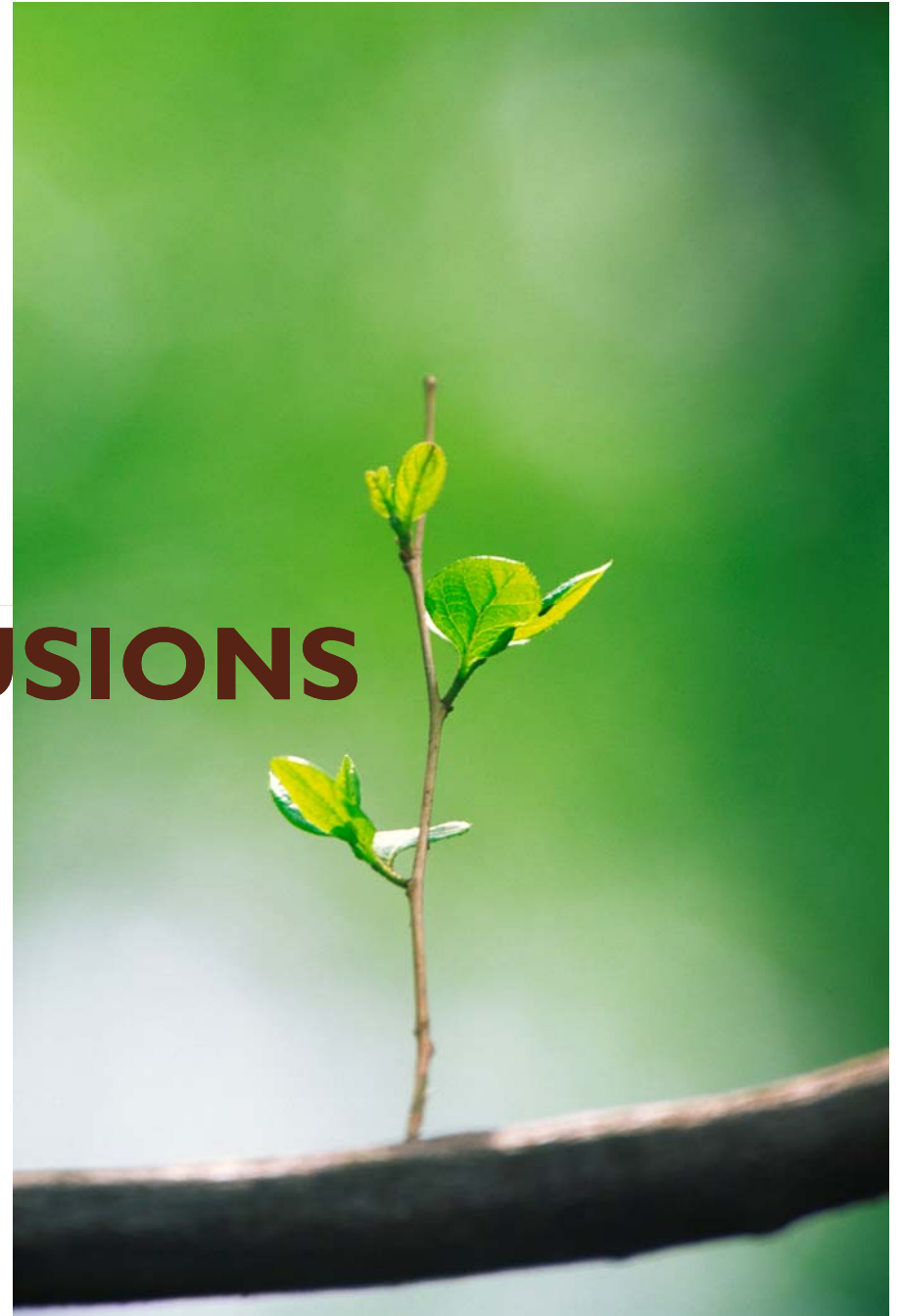



Conclusions

- Atarraya is a simple tool to simulate topology control protocols in wireless sensor networks
- Three experiments have been presented in this tutorial
 - Giant Component – Classic test and test for sparse networks
 - Single Topology – Evaluation of Topology Construction and Topology Maintenance protocols
 - Heterogeneous topologies
 - Multiple Topologies – Evaluation of the average behavior of a topology construction protocol
- These experiments are the most commonly performed in order to test and compare topology control algorithms



Conclusions

- Some topics where not included in this tutorial
 - Experiments when multiple sinks (and VNIs) are used
 - How to design a protocol for Atarraya
 - How to create new communication and energy models

More information

Miguel Labrador

labrador@cse.usf.edu

<http://www.cse.usf.edu/~labrador>

Pedro Wightman

pedrow@cse.usf.edu

<http://www.cse.usf.edu/~pedrow>

Atarraya

<http://www.cse.usf.edu/~labrador/Atarraya>

Topology Control

http://en.wikipedia.org/wiki/Topology_control

More Information

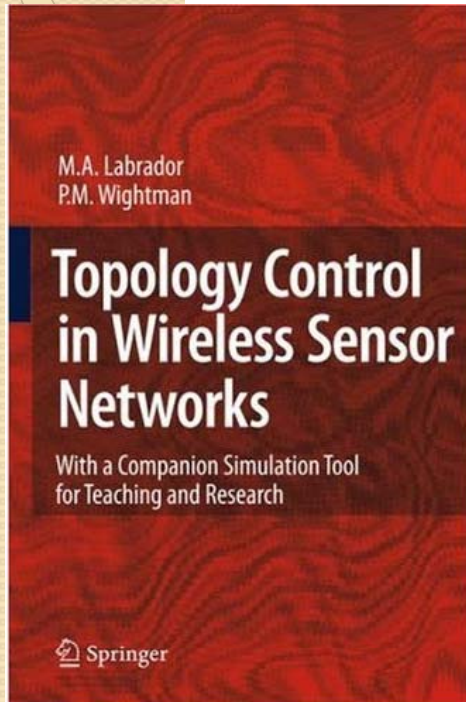

- Book: ["Topology Control in Wireless Sensor Networks - with a companion simulation tool for teaching and research"](#). Miguel Labrador and Pedro Wightman. Springer Science + Business Media B.V. 2009. ISBN: 978-1-4020-9584-9.
- Paper: [Atarraya: A Simulation Tool to Teach and Research Topology Control Algorithms for Wireless Sensor Networks](#). Pedro Wightman and Miguel A. Labrador. SimuTools 2009. March 2 - 6 Rome, Italy.

Thank You!





EXPERIMENTS PART V – ADVANCED SCENARIOS



Advanced Experiments

- Goal:
 - Learn how to create more complex scenarios
 - Learn how to run experiments with multiple topologies
- Experiment V-a
 - Heterogeneous topologies
- Experiment V-b
 - Multiple topologies



Deployment Generation – Heterogeneous Topologies

- Atarraya supports heterogeneous topologies
- These topologies are built as a union of smaller homogeneous nodes
- The set of parameters that describe each small homogeneous family of nodes is called **Creation Word**
 - A creation word is required for each set of nodes with the same characteristics

Deployment Generation – Heterogeneous Topologies

- The followings are the parameters that can be defined in a creation word

Parameter	Description
Number of Nodes	Integer value
Communication Radius	r_{comm} is an integer value
Sensing Radius	r_{sens} is an integer value
Position Distribution	<ul style="list-style-type: none"> - Uniform in a square area of size h and w, centered in (x, y) - Normal with $x' \in N(\mu_x, \sigma)$ and $y' \in N(\mu_y, \sigma)$ - Grid H-V: Distribute nodes in the deployment area with a distance of r_{comm} between nodes, so nodes are adjacent with their vertical and horizontal neighbors - Grid H V D: Distribute nodes in the deployment area with a distance of $r_{comm} \cdot \sqrt{2}$ between nodes, so nodes are adjacent with their vertical, horizontal and diagonal neighbors - Constant position: (x, y) for all nodes in the creation word - Center: (x, y) is the center of the deployment area - Manual: Use the mouse to select the position in the deployment area
Energy Distribution	<ul style="list-style-type: none"> - Constant position: $e \in \mathfrak{R}$ for all nodes in the creation word - Uniform with maximum energy e_{max} - Normal with $e' \in N(\mu_e, \sigma)$ - Poisson with λ_e
Sink?	This parameter determines if the nodes in the creation word are sink nodes
VNI Selection	This parameter associates sink nodes to the selected VNI
Inter-query time	Frequency of querying the sensor for readings. Only used by sensor-data protocols
Inter-reset time	Time period between the execution of time-triggered topology maintenance protocols
Energy threshold	Energy percentage differential used to invoke energy-triggered topology maintenance protocols. Every time the energy of a node changes this energy threshold value, since the last invocation of the topology maintenance protocol, the node will invoke the protocol again. For example, if the node has all its energy and the value is 0.10, the node will invoke the protocol at 90%, 80%, 70%, etc.

Experiment V-a

- Deployment Area: 500 x 500mts
- Nodes
 - 200 nodes, distributed uniformly in a rectangular area of 300x300, centered at (200,200). Each node will have a constant value of 1000 mJ of energy
 - 100 nodes, normally distributed with $\mu = (250,250)$, $\sigma = 50$. Each node will have a Poisson distributed random value for with $\lambda = 700\text{mJ}$
 - A single sink node in the center of the area
 - Communication radius = 50mts
 - Sensing radius = 25mts
- Protocols
 - Topology Construction: A3, with metrics $W1=0.5$ and $W2=0.5$, and linear combination of them
 - Topology Maintenance: DGTTRec with time period of 1200 time units
 - Sensing-Data protocol: Inter-query time of 15 t.u.
- Results
 - Stats stored
 - Lifetime results

Deployment Generation

Deployment area's size definition

Area = 500x500

Definition of first set of nodes

200 nodes, distributed uniformly in an area of 300x300 with center in (200,200), 1000 mJ of energy constant

When more than one configuration of nodes are deployed, each one must be defined separately. Include the parameters according to the screen

Each creation word must be added to the Node Creation List. This is done by clicking on the **Add** button

The screenshot shows the 'Deployment Options' window of a simulation software. The interface is divided into several sections:

- Deployment:** Contains fields for '# Nodes' (200), 'Comm Radius' (50), and 'Sensing Radius' (25). There is also a 'Sink?' checkbox and an 'Infrastructure Association' dropdown set to 'Black'.
- Deployment Visibility Area:** Contains fields for 'Width' (500) and 'Height' (0).
- Node Location Distribution:** Includes a dropdown set to 'Uniform', 'X' (200), 'Y' (200), 'Sigma' (5), and a 'Manual Pos.' button.
- Node Energy Distribution:** Includes a dropdown set to 'Constant', 'Max' (1000), 'Mean' (5), and 'Sigma'.
- Node Creation List:** A text area containing the string '0@0@200@50@25@10.0@0@200@200'. Below it is an 'Add' button highlighted with an orange box.
- Sink Creation List:** An empty text area.
- Batch Creation:** Includes a 'Batch Creation' checkbox, '# of Topologies' (1), 'Index start in:' (0), and a 'Progress:' field.
- Bottom Section:** Includes a 'Create Deployment' button, a 'Generate Deployment?' checkbox (checked), and a 'Check Connectivity Exhaustively' checkbox (checked).

Annotations on the image include:

- A red arrow pointing from the 'Deployment' section to the text 'Deployment area's size definition'.
- A blue arrow pointing from the 'Node Location Distribution' section to the text 'Definition of first set of nodes'.
- A green arrow pointing from the 'Add' button to the text 'Each creation word must be added to the Node Creation List...'.

Deployment Generation

Definition of **second set** of nodes

100 nodes, normally distributed
 $N((250,250),50)$, Poisson distributed
energy with $\lambda = 700mJ$

Deployment Options Atarraya Visualization Node Stats Report TC Theoretical

Deployment Other Params.

Deployment

# Nodes	Comm Radius	Sensing Radius	Infrastructure Association
100	50	25	<input type="checkbox"/> Sink? Black

Deployment Visibility Area

500 Width 500 Height 0 Bit Error Rate

Node Location Distribution

Normal 300 Width 300 Height

250 X 250 Y 50 Sigma Manual Pos.

Node Energy Distribution

Poisson 1000 Max 1000 Mean 700 La...

Node Creation List

0@0@200@50@25@10.0@0@200@200
0@0@100@50@25@10.0@1@250@250

Sink Creation List

Batch Creation

Batch Creation

1 # of Topologies

0 Index start in:

Progress:

Check Max. Trials

Add Remove Clear

Create Deployment Generate Deployment?
 Check Connectivity Exhaustively

Deployment Generation

Definition of sink nodes

A single sink node in the center of the area

- When creating a sink node, the checkbox **Sink?** must be selected. It will change the parameters to the default values: *1 sink in the center of the deployment area*
- By default, every sink is associated with the Black VNI, keep this parameter as it is. This association can be changed depending on the topology requirements
- Energy is not important to define given that the sink is assumed to have an infinite source of energy
- After defining all the parameters, click on the **Add button** . It will include the definition of the sink nodes in the Sink Creation List

The screenshot displays the 'Deployment Options' window of a simulation software. The interface is divided into several sections:

- Deployment:** Contains fields for '# Nodes' (set to 1), 'Comm Radius' (50), and 'Sensing Radius' (25). A red box highlights the 'Infrastructure Association' section, which includes a checked 'Sink?' checkbox and a dropdown menu set to 'Black'.
- Deployment Visibility Area:** Includes fields for 'Width' (500), 'Height' (0), and 'Bit Error Rate'.
- Node Location Distribution:** Features a dropdown set to 'Center', 'Width' (500), 'Height' (500), and 'Sigma' (50). A 'Manual Pos.' button is also present.
- Node Energy Distribution:** Includes a dropdown set to 'Constant', 'Max' (1000), and 'Mean' (700).
- Node Creation List:** A list box containing coordinates like '0@0@200@50@25@10.0@0@200@200'.
- Sink Creation List:** A list box containing coordinates like '1@0@1@50@25@10.0@3@300@300@!'. An orange box highlights the 'Add' button below this list.
- Batch Creation:** Includes a 'Batch Creation' checkbox, '# of Topologies' (1), and 'Index start in:' (0).
- Progress:** A progress bar and a checked 'Check Max. Trials' checkbox.
- Bottom Section:** Includes a 'Create Deployment' button, a checked 'Generate Deployment?' checkbox, and a checked 'Check Connectivity Exhaustively' checkbox.

Deployment Generation

Definition of the metric parameter

A3, with metrics $W1=0.5$ and $W2=0.5$, and linear combination of them

Definition of the topology management and sensing-data protocols parameters

DGTTRec with inter-reset period of 1200 time units and Interquery time of 15 t.u.

The interquery time will dictate how frequently the sensor is going to be queried and when a message will be sent to the sink node

Now click on the **Create Deployment Button**

The screenshot shows a software window titled "Deployment Generation" with a menu bar containing "Deployment Options", "Atarraya", "Visualization", "Node Stats", "Report", and "TC Theoretical". The main interface has two tabs: "Deployment" and "Other Params.". The "Other Params." tab is active, showing several configuration sections:

- Metric Definition:** A dropdown menu is set to "Linear Combination (W1*Metric1+W2*M...". Below it, a "Candidate Grouping Step" is set to 0.25.
- Weights:** Two input fields are set to 0.5, labeled "W1" and "W2". There is a checkbox for "Create all steps" which is unchecked. A "Step" field is set to 0.20, and a "Set Weights Now" button is present.
- S-D protocol Interquery time:** An input field is set to 15, labeled "Interquery time", with a "Set InterQ Time Now" button.
- TM Protocols Variables:** An input field is set to 1200, labeled "Inter-Reset Period", and another is set to 0.9, labeled "Energy Threshold Step".

At the bottom of the window, there is a "Create Deployment" button highlighted with a red box. To its right are two checked checkboxes: "Generate Deployment?" and "Check Connectivity Exhaustively".

Deployment Generation

- Once the Create Deployment button is pressed, we obtain this topology

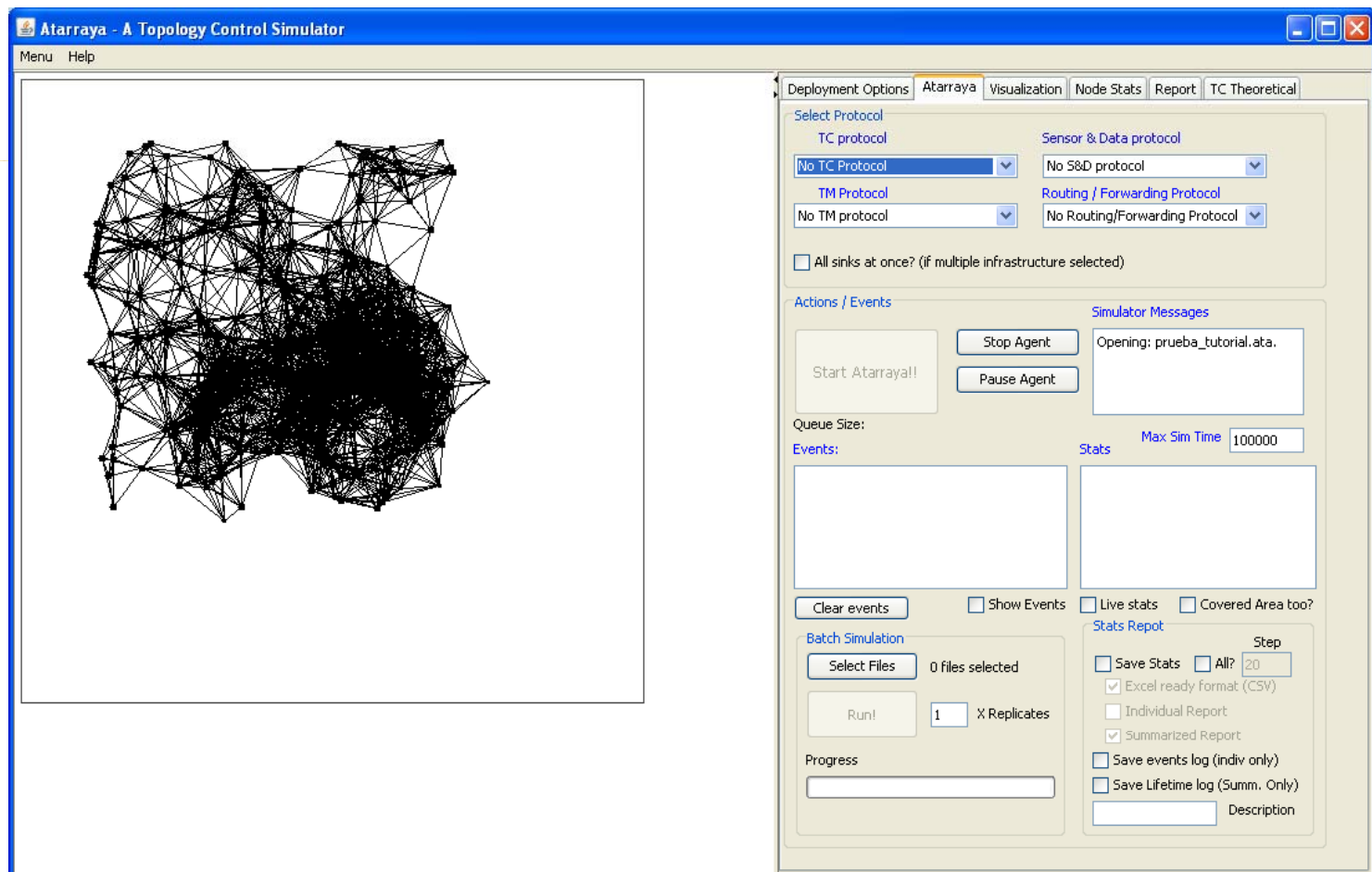

Protocol Selection

Definition of the protocols

A3, DGTTRec, Simple S&D, Simple Forwarding

Definition of the topology management and sensing-data protocols parameters

Stats stored, Lifetime results

•Again, click on the **Start Aarraya** button. DO NOT USE THE RUN BUTTON FOR THIS EXPERIMENT!

The screenshot shows the Atarraya software interface with the following components:

- Deployment Options:** Atarraya, Visualization, Node Stats, Report, TC Theoretical
- Select Protocol:**
 - TC protocol: A3
 - Sensor & Data protocol: Simple S&D protocol
 - TM Protocol: DGTTRec
 - Routing / Forwarding Protocol: Simple Forwarding
- All sinks at once? (if multiple infrastructure selected)
- Actions / Events:**
 - Start Aarraya!! (highlighted with a red box)
 - Stop Agent
 - Pause Agent
- Queue Size:** [Empty field]
- Events:** [Empty list box]
- Stats:** Max Sim Time: 100000
- Live stats
- Covered Area too?
- Stats Report:**
 - Save Stats
 - All? 20 Step
 - Excel ready format (CSV)
 - Individual Report
 - Summarized Report
 - Save events log (indiv only)
 - Save Lifetime log (Summ. Only)
- Batch Simulation:**
 - Select Files: 0 files selected
 - Run! 1 X Replicates
- Progress:** [Progress bar]
- Simulator Messages:** Opening: prueba_tutorial.ata.
- Footer:** }_tutorial_heter_a3 Description

Simulation Results

Summarized lifetime results figure

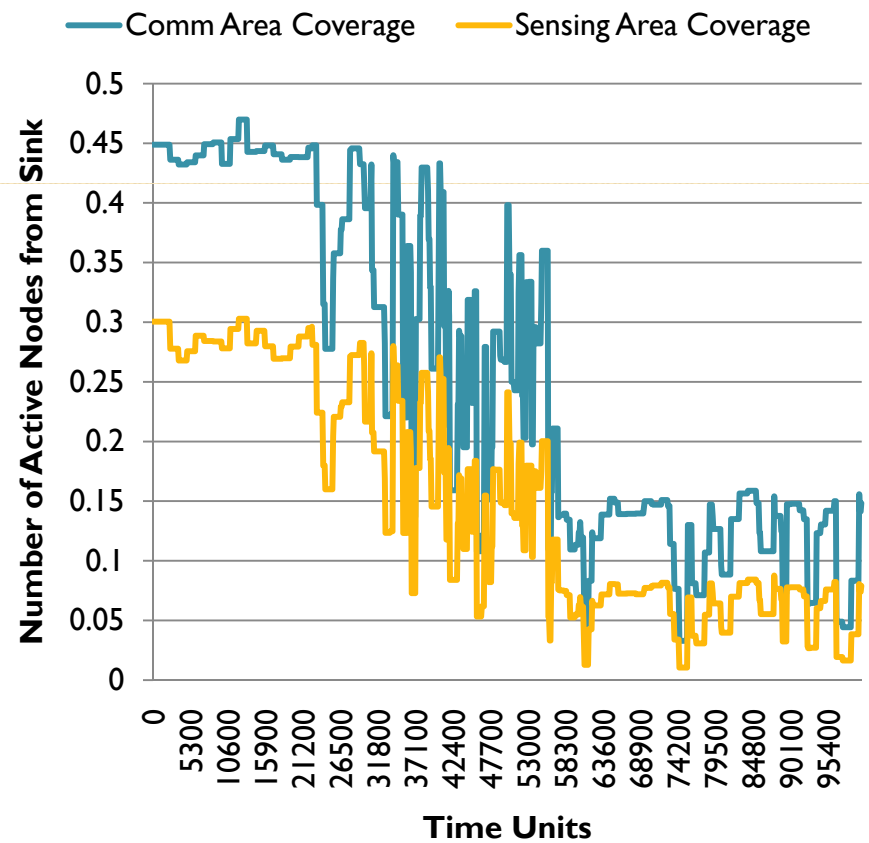
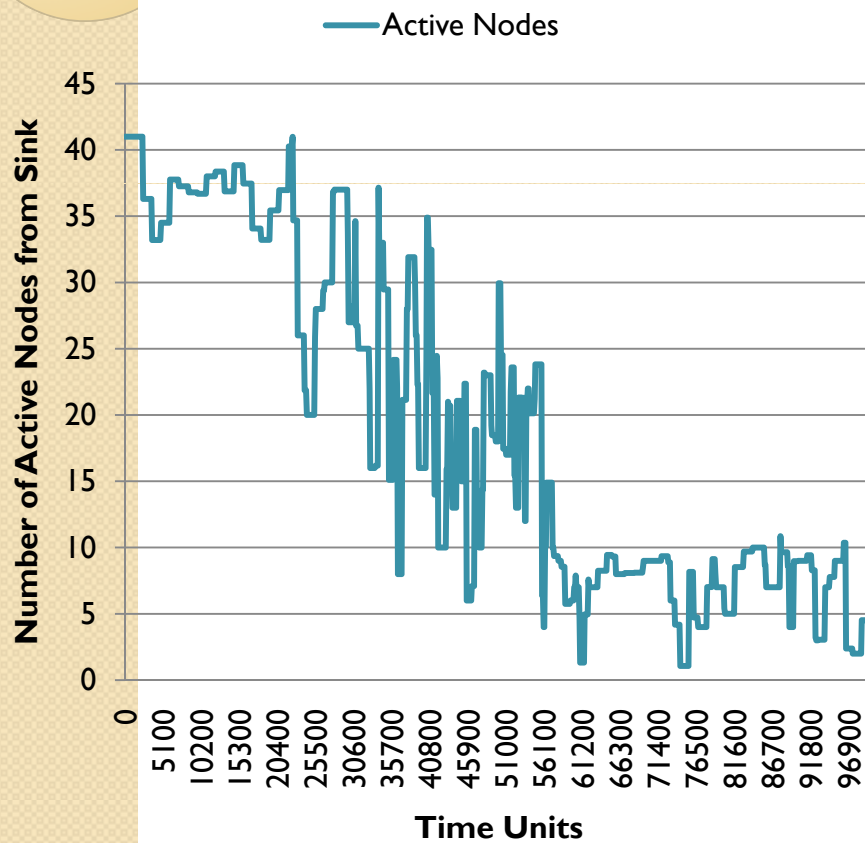

Experiment V-b

- Area: 600 x 600mts
- 100 topologies
- Nodes
 - 200 nodes, uniformly distributed in the area, 1000 mJ of energy constant
 - A single sink node in the center of the area
- Communication radius = 80mts
- Sensing radius = 48mts
- Protocols
 - Topology Construction: A3Cov, with metrics $W1=0.5$ and $W2=0.5$, and linear combination of them
- Results
 - Average number of active nodes
 - Average Sensing Coverage
 - 2 replicates per topology

Introduction

- The process to do an experiment in Atarraya with multiple topologies is basically the same as with just one topology:
 - Topology Generation
 - Definitions are the same, but many topologies will be created and stores in files, instead of only one
 - Simulation Execution
 - The user must select the files to be tested
 - Simulation results
 - There will be no visual representation of the topologies
 - The results file will include the statistics from all the topologies being executed

Deployment Generation

- The definition of the topologies works exactly in the same way as for a single topology
 - All the topologies to be generated will have the same characteristics
- Define the parameters and click the Create Batch button
 - 100 topologies
 - Check Max. Trials: Atarraya will try to generate all topologies; however it may be possible that the configuration drives to have unconnected networks. A maximum number of failed trials is allowed. In the case it is reached, Atarraya will ask the user if he/she wants to continue or not

The screenshot shows the 'Deployment Options' window in the Atarraya software. The 'Deployment' tab is active, and the 'Batch Creation' section is highlighted with a blue box. The 'Batch Creation' section includes a checked 'Batch Creation' checkbox, a text input field for '# of Topologies' containing '100', a text input field for 'Index start in:' containing 'U', a 'Progress:' label with an empty progress bar, and a checked 'Check Max. Trials' checkbox. The 'Deployment' section includes fields for '# Nodes' (200), 'Comm Radius' (80), 'Sensing Radius' (48), 'Infrastructure Association' (Black), 'Deployment Visibility Area' (Width: 600, Height: 0), 'Node Location Distribution' (Uniform, Width: 600, Height: 300, Sigma: 5), and 'Node Energy Distribution' (Constant, Max: 1000, Mean: 5). The 'Sink Creation List' section is empty. The 'Create Batch' button is visible at the bottom left, and the 'Generate Deployment?' checkbox is checked at the bottom right.

Deployment Generation

Definition of the metric parameter

A3, with metrics $W1=0.5$ and $W2=0.5$, and linear combination of them

Now click on the **Create Batch** button.

The screenshot shows a software window titled "Deployment Generation" with a blue header bar. Below the header are several tabs: "Deployment Options", "Atarraya", "Visualization", "Node Stats", "Report", and "TC Theoretical". The "Other Params." tab is selected. Inside this tab, there are several sections:

- Metric Definition**: A dropdown menu is set to "Linear Combination (W1*Metric1+W2*M...". Below it, a "Candidate Grouping Step" is set to 0.25.
- Weights**: Two input fields are set to 0.5, labeled "W1" and "W2". There is a checkbox for "Create all steps" which is unchecked. Below these is a "Step" field set to 0.20 and a "Set Weights Now" button.
- S-D protocol Interquery time**: An "Interquery time" field is set to 15, with a "Set InterQ Time Now" button.
- TM Protocols Variables**: An "Inter-Reset Period" field is set to 1000, and an "Energy Threshold Step" field is set to 0.9.

At the bottom of the window, there is a "Create Batch" button, a checkbox for "Generate Deployment?" (unchecked), and a checked checkbox for "Check Connectivity Exhaustively".

Protocol Selection and Simulation Execution

Definition of the protocol
A3

Selection of the files and execution

Batch simulation, 2 replicates per experiment

- Click on the **Select Files** button to select the topology files
- Specify the number of replicates per experiments. The result of each replicate experiment will be stores individually
- Start the batch simulation by clicking in the **Run!** button, on the batch simulation panel. **DO NOT USE THE START ATARRAYA BUTTON FOR THIS KIND OF EXPERIMENT**

The screenshot shows the 'Deployment Options' window for 'Atarraya'. The 'Select Protocol' section is highlighted with a blue box and contains the following settings: TC protocol: A3 Coverage; Sensor & Data protocol: No 5&D protocol; TM Protocol: No TM protocol; Routing / Forwarding Protocol: No Routing/Forwarding Protocol. Below this is a checkbox for 'All sinks at once? (if multiple infrastructure selected)'. The 'Actions / Events' section has buttons for 'Start Atarraya!!', 'Stop Agent', and 'Pause Agent'. The 'Batch Simulation' section is highlighted with a red box and contains a 'Select Files' button (with '100 files selected'), a 'Run!' button, and a field for '2 X Replicates'. The 'Stats Report' section is highlighted with a green box and contains checkboxes for 'Save Stats', 'Excel ready format (CSV)', 'Individual Report', and 'Summarized Report'. The 'Max Sim Time' is set to 100000.

Definition of the results parameters
Stats stored, Summarized report, Excel Ready
Summarized report will store the results of all topologies in just one file.
Individual report will create log files per topology

Simulation Execution

**The panel will show you also
the progress of the
experiment**
Instance reflects the current
replicate being executed

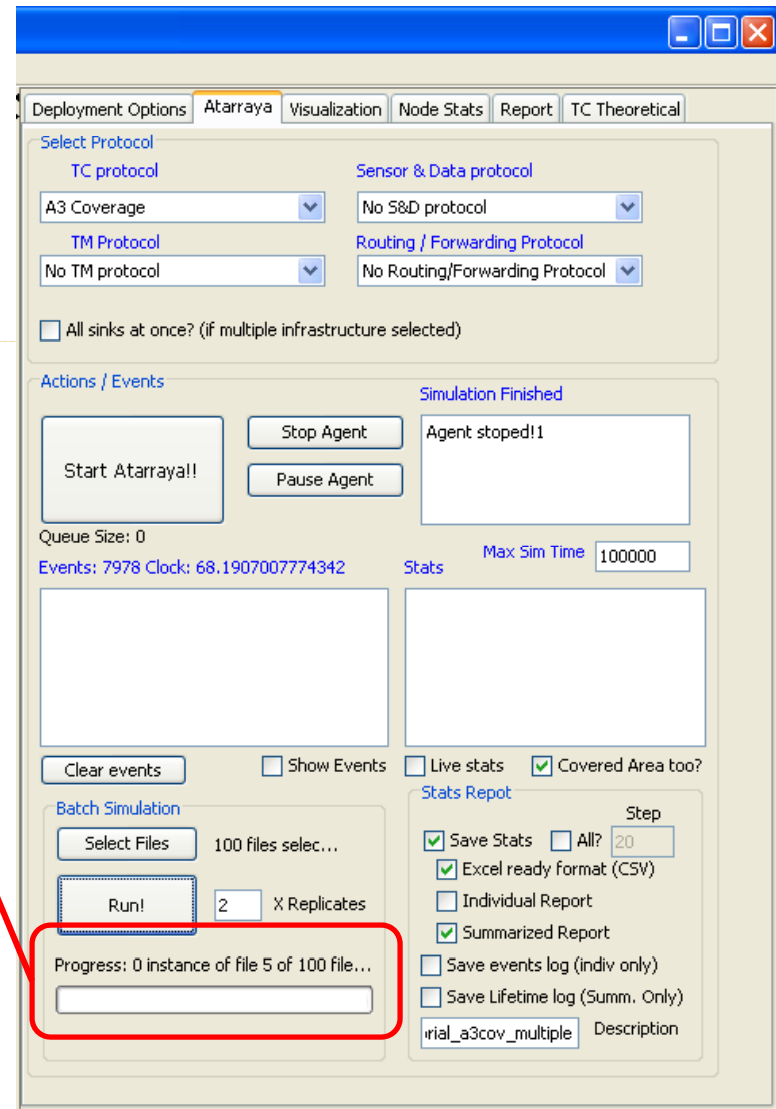

Simulation Results

- The statics file will contain the results of each single execution, including the replicates

Stats from the example (from the stats file)

Filename	Clock	# of Node	# of Sinks	Not Cover Ratio	Not Visite	Avg. Level	Av
200_1_80_600_600_21_4_2009@22_58_27_0.ata	66.31182	200	1	0	0	4.79602	1
200_1_80_600_600_21_4_2009@22_58_27_0.ata	72.95534	200	1	0	0	4.910448	1
200_1_80_600_600_21_4_2009@22_58_27_1.ata	61.00217	200	1	0	0	4.437811	9
200_1_80_600_600_21_4_2009@22_58_27_1.ata	61.18851	200	1	0	0	4.437811	9
200_1_80_600_600_21_4_2009@22_58_27_2.ata	69.34403	200	1	0	0	4.781095	9
200_1_80_600_600_21_4_2009@22_58_27_2.ata	69.00372	200	1	0	0	4.741294	9
200_1_80_600_600_21_4_2009@22_58_27_3.ata	68.53743	200	1	0	0	4.676617	9
200_1_80_600_600_21_4_2009@22_58_27_3.ata	68.99658	200	1	0	0	4.656716	9
200_1_80_600_600_21_4_2009@22_58_27_4.ata	68.22547	200	1	0	0	4.716418	1
200_1_80_600_600_21_4_2009@22_58_27_4.ata	67.93862	200	1	0	0	4.716418	1
200_1_80_600_600_21_4_2009@22_58_27_5.ata	69.60565	200	1	0	0	4.552239	9
200_1_80_600_600_21_4_2009@22_58_27_5.ata	69.78525	200	1	0	0	4.552239	9
200_1_80_600_600_21_4_2009@22_58_27_6.ata	69.23162	200	1	0	0	4.552239	1
200_1_80_600_600_21_4_2009@22_58_27_6.ata	68.89121	200	1	0	0	4.552239	1
200_1_80_600_600_21_4_2009@22_58_28_10.ata	63.85985	200	1	0	0	4.930348	9
200_1_80_600_600_21_4_2009@22_58_28_10.ata	65.50231	200	1	0	0	4.875622	9

Notice that each file is being executed twice!

Simulation Results

- When several scenarios are used, results like this one can be obtained
 - Each point on the lines is the average of multiple topologies with the same characteristics

